



HAL
open science

Experimental study of thermal deformation in a 3D-printing process with polymer filament

T. Kobayashi, J. Nishii, M. Ishida, H. Furumoto, Y. Utsumi, H. Kanematsu,
Cosmin Gruescu

► **To cite this version:**

T. Kobayashi, J. Nishii, M. Ishida, H. Furumoto, Y. Utsumi, et al.. Experimental study of thermal deformation in a 3D-printing process with polymer filament. *Journal of Advanced Manufacturing Technology*, 2019, *Journal of Advanced Manufacturing Technology*, 13 (1), pp.61-69. hal-03366798

HAL Id: hal-03366798

<https://hal.univ-lille.fr/hal-03366798v1>

Submitted on 5 Oct 2021

HAL is a multi-disciplinary open access archive for the deposit and dissemination of scientific research documents, whether they are published or not. The documents may come from teaching and research institutions in France or abroad, or from public or private research centers.

L'archive ouverte pluridisciplinaire **HAL**, est destinée au dépôt et à la diffusion de documents scientifiques de niveau recherche, publiés ou non, émanant des établissements d'enseignement et de recherche français ou étrangers, des laboratoires publics ou privés.



Distributed under a Creative Commons Attribution - NonCommercial - NoDerivatives 4.0
International License

EXPERIMENTAL STUDY OF THERMAL DEFORMATION IN A 3D-PRINTING PROCESS WITH POLYMER FILAMENT

T. Kobayashi¹, J. Nishii¹, M. Ishida¹, H. Furumoto², Y. Utsumi³,
H. Kanematsu⁴ and C. Gruescu⁵

¹Department of Electronics & Control Engineering,
National Institute of Technology, Tsuyama College,
624-1 Numa, Tsuyama, Okayama 708-8509, Japan.

²Department of Industrial Engineering,
Hiroshima Kokusai Gakuin University,
6-20-1 Nakano, Aki-Ku, Hiroshima 739-0321, Japan.

³Laboratory of Advanced Science and Technology for Industry,
University of Hyogo, 3-2-1 Kouto, Kamigori-Cho, Ako-Gun,
Hyogo 678-1297, Japan.

⁴Department of Materials Science & Engineering,
National Institute of Technology, Suzuka College,
Shiroko-cho, Suzuka, Mie 510-0294, Japan.

⁵Department GMP,
Institute Univrsitaire de Techhology A de Lille,
BP 90179, 59653 Villeneuve d'Ascq Cedex, France.

Corresponding Author's Email: t-koba@tsuyama-ct.ac.jp

Article History: Received 7 December 2018; Revised 22 February 2019;
Accepted 17 April 2019

ABSTRACT: Thermal deformation generated in a 3D-printing process was investigated mainly by the measurement of the radius of curvature. 3D-printing have been widely applied in industrial products. High end models of 3D-printer have heating and heat retention function to reduce thermal deformation and further they have sometimes equipped with a computational simulation code to predict the thermal deformation. In the present study, a predicting method of thermal deformation for a low end 3D-printer was investigated so that the investment for the equipment is minimized, then the following results were obtained. Dominating parameters were quantified by the measurement and multiple regression analysis of proto-typed products with different dimensions, that is, it was found that the parameters having greater influence on the deformation were in the order of the amount of filament, the length, the width, the height, bottom area, the volume and the manufacturing time, respectively. A simple but convenient regression equation was obtained which will be used for an estimation and simulation of the thermal deformation in production with the 3D-printer without using any expensive simulation code.

KEYWORDS: *Thermal Deformation; 3D Printer; Polymer Filament; Predicting Method; Multiple Regression Analysis*

1.0 INTRODUCTION

In recent years, the presence of 3D printers is becoming indispensable as a means of development and invention [1-4]. The application fields have been widely expanded from construction, dentistry, medicine, electronics, automotive, robot and aerospace [5-11]. However, at the same time, several problems have already been filed. As a principle of 3D printer, it is a molding method (hot melt lamination method) in which a filler is melted then laminated and solidified, therefore "thermal deformation" generated in the process is one of the problems [12-13]. High end models of 3D-printer have heating and heat retention function with an enclosure to reduce thermal deformation, further they have sometimes equipped with a computational simulation code to predict the thermal deformation [14-16]. However, low end models are desirable as long as the deformation can be acceptable or predictable, from a view of economical. In the present study, a predicting method of thermal deformation for a low end 3D-printer using regression analysis was investigated without using expensive simulation code, so that the investment for the equipment is minimized.

2.0 METHODOLOGY

The members prototyped with a 3D printer are a 1/10 reduced model of the lower body of the actual mobile suit, which has a height of 7 m as shown in Figure 1. As large the members, a total of nine members, feet, legs, and thighs were fabricated as shown in Figure 2 and as small members, joint members and cylinders were trial manufactured shown in Figure 3.

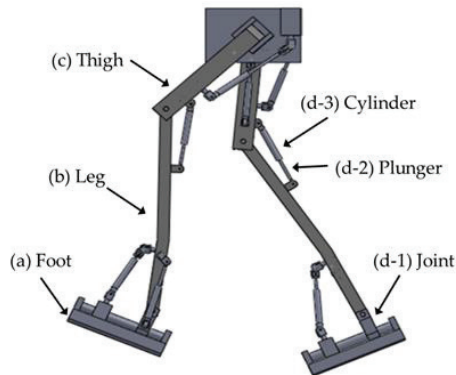

Figure 1: A 1/10 reduced model of the lower body of the actual mobile suit having a height of 7 m

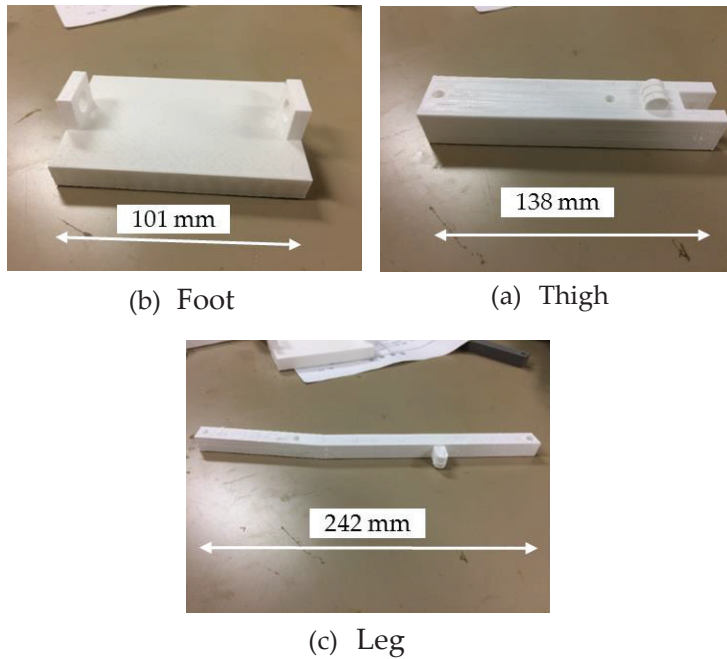

Figure 2: Examples of prototyped members (large parts)

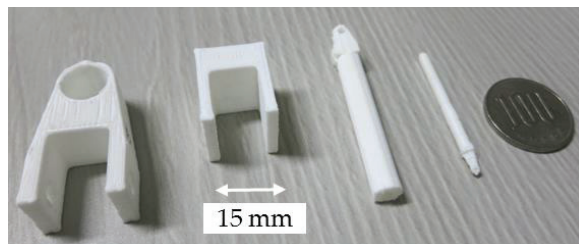

Figure 3: Examples of prototyped members (small parts)

2.2 Equipment and Condition

The 3D printer used is "Makerbot Replicator +" (produced by Makerbot Co, Ltd). This 3D printer is a type of printer without the enclosure described above. The nozzle for filament moves only in the horizontal direction, and the base floor is raised and lowered in vertical direction. The filament used is "MakerBot 1.75 mm PLA large spool (gray, white)". It should be noted that the PLA filament is an environmentally decomposable resin [17]. The 3D CAD data were converted to the STL file formats and supplied to the printer. It is possible for the printer to add a function called "support". This function makes possible to form overhung portion without collapse by constructing vertical posts, further at the same time, the strength of

the hollow parts are also improved [17]. Therefore, the effect of with and without support on deformation were also investigated. After the proto-typed, the thermal deformation was measured as the radius of curvature in the direction of the length as shown in Figure 4.

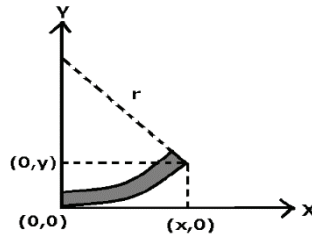

Figure 4: Measurement of the radius of curvature (thermal deformation)

2.3 Temperature Distribution and Temperature Change

In order to examine the degree of thermal deformation, a rectangular box of 20 mm in length and 10 mm in height as shown in Figure 5 was prepared as a specimen. Then, the temperature distribution was measured using the radiation type thermometer after its preparation stage and fabrication. In the preparation stage, the ceiling of the sample was measured every minute, and the whole image was measured after preparation. The filament (resin) melts out, and the temperature of the nozzle at the start of fabrication was 215°C. As shown in Figure 6, the temperature of the molded part was around 100°C at the beginning of the production, however after the lamination is superposed, the temperature of the molded part rose to about 120°C. This is considered to be due to the fact that the heat of the already laminated part is accumulated when newly laminating, and it is not completely cooled. In addition, the sample shown in Figure 5 was completed in about 8 minutes. The temperature from the bottom steadily declined and converged to about room temperature. The temperature measured after completion (9 to 10 minutes) is shown in Figure 7. In the temperature distribution shown in Figure 7, the minimum temperature was set at 24°C (Room temperature) and the maximum temperature was set at 55°C (Ceiling). The temperature is already lower than the ceiling (red and white), but the part at the beginning (yellowish green) is lowered to room temperature from 24 to 30°C, as shown in Figure 7, the top is not completely cooled even after completion.

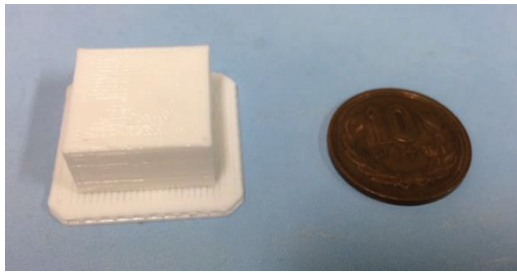

Figure 5: Specimen for temperature measurement

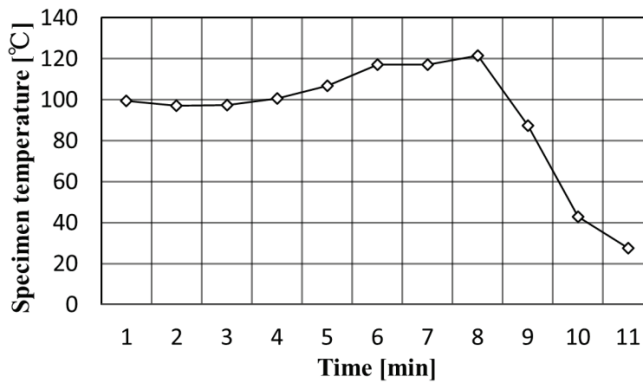

Figure 6: Specimen temperature measured during 3D typing

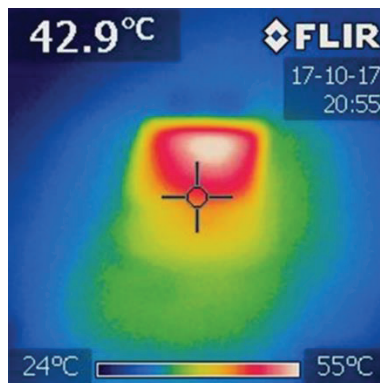

Figure 7: Temperature distribution of specimen after the 3D typing

3.0 RESULTS AND DISCUSSION

3.1 Multiple Regression Analysis

When analyzing, the necessary condition is called "independent variable" for example, if a rent for an apartment (one room) is estimated, the independent variable will be the distance from the

station, the size of the room, the age of years, the popularity and the influence factor from the independent variables will be found to the conclusion. For the analysis to be performed this time, independent variables are the vertical dimension, the horizontal dimension, the height, the bottom area, the volume, with or without of support, the production time and the amount of filament used.

Multiple regression analysis was performed on the independent variables and the measurement results of the radius of curvature of each member. Figure 8 shows the comparison between the measured values and the results calculated from the regression equation.

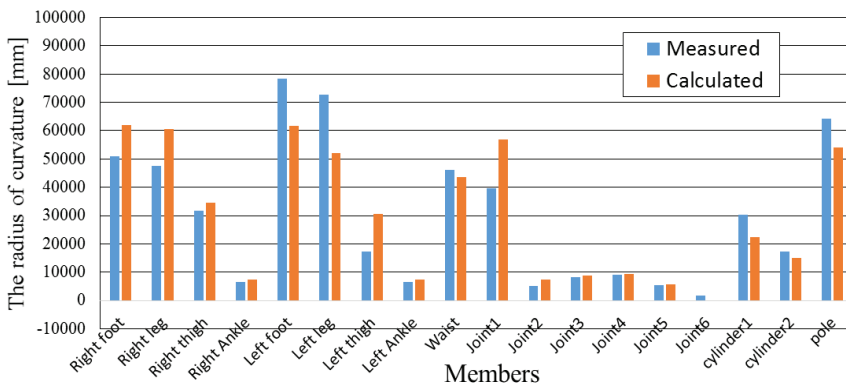

Figure 8: Comparison of the radius of curvature between the measured and the results calculated from the regression equation

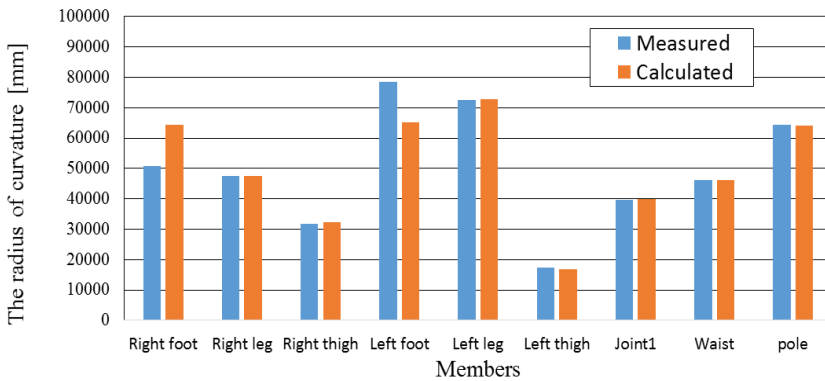

Figure 9: Comparison of the radius of curvature between the measured and the results calculated from the regression equation (regarding relatively large members)

Next, we divide it into the large and small members and multiple regression analysis was performed again. The results are then shown in Figures 9 and 10. The multiple correlation R was showed 0.996, which proved a very good correlation for the small members (Figure 10). The multiple correlation R decreased slightly from 0.805 to 0.749 for the large members (Figure 9). Therefore, it was found that the correlation varies depending on the size of the member.

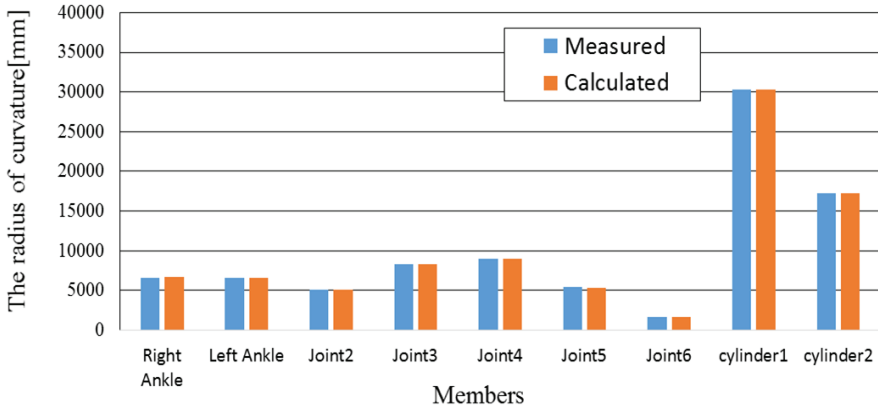

Figure 10: Comparison of the radius of curvature between the measured and the results calculated from the regression equation (regarding relatively small members)

3.2 Influence Factor

Influence factor of each parameter which is the object of this research was obtained by the following equations and the results are summarized in Figure 11.

$$IF = RC \times Ra \tag{1}$$

$$Ra = \max X_i - \min X_i \tag{2}$$

where IF is the influence factor, RC is the regression coefficient, Ra is the range of each parameter, $\max X_i$ is the maximum value of each parameter and $\min X_i$ is minimum value of each parameter. From Figure 11, it was found that the parameters having greater influence on deformation were in the order of the amount of filament, the length, the width, the height, bottom area, the volume, the manufacturing time and the length, respectively.

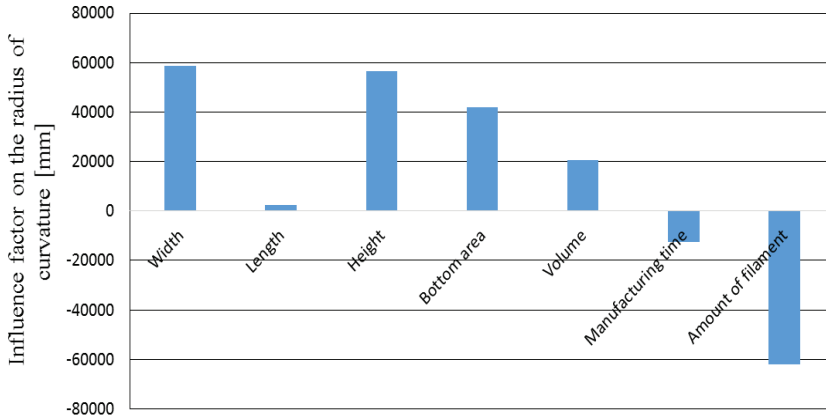

Figure 11: Influence factor of each parameter on the radius of curvature

4.0 CONCLUSION

In the present study, a predicting method of thermal deformation for a low end 3D-printer was investigated. Dominating parameters were quantified by the measurement and multiple regression analysis of proto-typed products with different dimensions, that is, it was found that the parameters having greater influence on deformation were in the order of the amount of filament, the length, the width, the height, bottom area, the volume and the manufacturing time, respectively. A simple but convenient regression equation was obtained for an estimation and simulation of the thermal deformation in production with the 3D-printer without using any expensive simulation code.

REFERENCES

- [1] X. Wang, M. Jiang, Z. Zhou, J. Gou and D. Hui, "3D printing of polymer matrix composites: a review and prospective", *Composites Part B*, vol. 110, pp. 442–458, 2017.
- [2] M. Chapiro, "Current achievements and future outlook for composites in 3D printing", *Reinforced Plastics*, vol. 60, no. 6, pp. 372–375, 2016.
- [3] S. Tranchard and V. Rojas. (2015). *Manufacturing our 3D Future* [Online]. Available: <https://www.iso.org/news/2015/05/Ref1956.html>
- [4] Z. Abdullah, H. Y. Ting, M. A. M. Ali, M. H. F. M. Fauadi, M. S. Kasim, A. Hambali, M. M. Ghazaly and F. Handoko, "The Effect of Layer Thickness and Raster Angle on Tensile Strength and Flexural Strength for Fused Deposition Modeling (FDM) Parts", *Journal of Advanced Manufacturing Technology*, vol. 12, no. 1(4), pp.147-158, 2018.

- [5] K. Yurief. (2017). *This robot can 3D print a building in 14 hours* [Online]. Available: <http://money.cnn.com/2017/05/02/technology/3d-printed-building-mit/>
- [6] J.W. Stansbury and M.J. Idacavage, "3D printing with polymers: challenges among expanding options and opportunities", *Dental Materials*, vol. 32, no. 1, pp. 54-64, 2016.
- [7] F.P. Melchels, J. Feijen and D.W. Grijpma, "A review on stereo lithography and its applications in biomedical engineering", *Biomaterials*, vol.31, no. 24, pp. 6121–6130, 2010.
- [8] E. Macdonald, R. Salas, D. Espalin, M. Perez and E. Aguilera, "3D printing for the rapid prototyping of Structural Electronics", *IEEE Access*, vol. 2, no. 4, pp. 234-242, 2014.
- [9] N. Hall. (2016). *Top 10 3D Printed Automotive Industry Innovations Available Right Now, in 3D Printing Industry* [Online]. Available: <https://3dprintingindustry.com/news/3d-printing-automotive-industry-2-82838/>
- [10] J. Lee, J. An and C. Chua, "Fundamentals and applications of 3D printing for novel materials", *Applied Materials Today*, vol. 7, pp.120–133, 2017.
- [11] R. Liu, Z. Wang, T. Sparks, F. Liou and J. Newkirk, "Aerospace applications of laser additive manufacturing", in *Laser Additive Manufacturing: Material, Design, Technologies and Applications*. Duxford, UK: Woodhead Publishing, 2017, pp. 351-371.
- [12] W. Wu, W. Ye, Z. Wu , P. Geng, Y. Wang and J. Zhao, "Influence of Layer Thickness, Raster Angle, Deformation Temperature and Recovery Temperature on the Shape-Memory Effect of 3D-Printed Polylactic Acid Samples", *Materials*, vol. 10, no. 8, pp. 1-16, 2017.
- [13] S.L. Messimer, A. E. Patterson, N. Muna, A. P. Deshpande and T. R. Pereira, "Characterization and Processing Behavior of Heated Aluminum-Polycarbonate Composite Build Plates for the FDM Additive Manufacturing Process", *Journal Manufacturing and Materials Processing*, vol. 2, no. 1, pp. 1-27, 2018.
- [14] T. Mukherjee, V. Manvatkar, A. De and T. DebRoy, "Mitigation of thermal distortion during additive manufacturing", *Scripta Materialia*, vol. 127, pp. 79-83, 2017.
- [15] S. F. Costa, F. M. Duarte and J. A. Covas, "Thermal conditions affecting heat transfer in FDM/FFE: a contribution towards the numerical modelling of the process", *Virtual and Physical Prototyping*, vol. 10, no. 1, pp. 35-45, 2015.
- [16] A.A. D'Amico, A. Debaie, and A. M. Peterson, "Effect of layer thickness on irreversible thermal expansion and interlayer strength in fused deposition modeling", *Rapid Prototyping Journal*, vol. 23, no. 5, pp. 943-953, 2017.
- [17] MakerBot Industries. (2014). *Makerbot replicator desktop 3D printer: User manual* [Online]. Available: http://download.makerbot.com/replicator/MB_Replicator_UserManual.pdf

