

Synthesis of polycyclic spiro naphthofuran derivatives via acid-catalyzed domino reaction of 2-naphthol with tetraarylbut-2-yne-1,4-diols

Céu M. Sousa,¹ Jerome Berthet,² Stephanie Delbaere² and Paulo J. Coelho*¹

¹ Centro de Química-Vila Real, Universidade de Trás-os-Montes e Alto Douro, 5000-801 Vila Real, Portugal

² Faculté des Sciences Pharmaceutiques et Biologiques, Université Lille Nord de France, UDSL, CNRS UMR 8516, F-59006 Lille, France

Email: Paulo J. Coelho – pcoelho@utad.pt

URL: www.cqvr.purpleprofile.pt/applied-organic-chemistry/

* Corresponding author

Abstract:

The acid-catalyzed condensation of 2-naphthols with tetraphenylbut-2-yne-1,4-diols affords a mixture of spiro[indene-1,1'-naphthofurans] and dinaphthofurans through a cascade of intramolecular reactions, whereas using the more reactive thienyltriphenylbut-2-yne-1,4-diol leads to the formation of a single spiranic compound joining a cyclopenta[*b*]thiophene to a naphtho[2,1-*b*]furan.

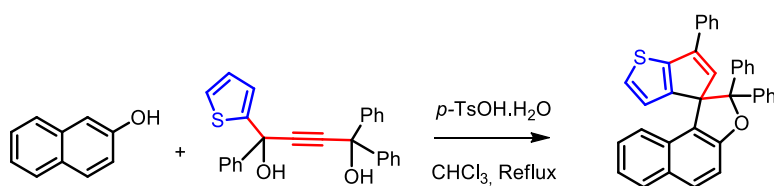

Keywords: Acid catalysis; cyclopenta[*b*]thiophene; domino reaction; naphthofuran; spiro compounds.

Short text to go with the table of contents

An easy synthesis of complex spiro compounds was developed using the acid-catalyzed condensation of 2-naphthols with tetraphenylbut-2-yne-1,4-diols. The reaction proceeds through a cascade of intramolecular reactions.

Topic Key

Domino reactions

Polycyclic spiro compounds

Introduction

Domino reactions are quite common in nature. The biosynthesis of complex compounds through a series of successive reactions enchants any organic chemist, although, usually, each step is catalyzed by a different enzyme [1-8]. Whilst common synthetic procedures routinely involve the stepwise formation of each bond in the target molecule, in domino reactions, several bonds are formed and different reactions occur successively, without the need to isolate the intermediates, change the reaction conditions or add more reagents. There are many examples of such transformations developed in the laboratories, most of them involving 2-3 reactions, which allows the preparation of complex molecules from simple reagents [9-14]. The acid-catalysed synthesis of vinylidene-naphthofurans from 2-naphthols and tetraphenylbut-2-yne-1,4-diols, at room temperature, is an example of such domino reactions involving 3 steps [15] (**Scheme 1**).

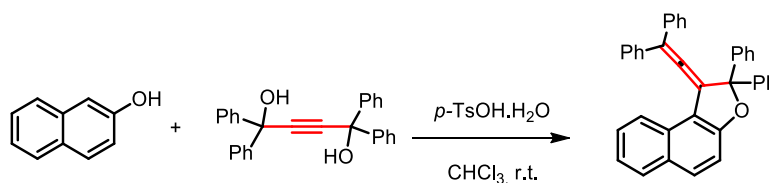

Scheme 1: Synthesis of vinylidene-naphthofuran from 2-naphthol and tetraphenylbut-2-yne-1,4-diol.

Vinylidene-naphthofurans show acidochromic properties being converted, after adding trifluoroacetic acid (TFA), into a violet cationic species formed through the addition of one proton to the allene group and overture of the furan ring (**Scheme 2**). The process is reversible and upon NEt_3 addition, the initial uncoloured vinylidene-naphthofurans are recovered. These molecules show also photochromic properties when they come in contact with an acidic environment and exposed to the UV light. The process originates the same coloured species and is reversible, in the absence of light, the coloured species returns thermally to the initial uncoloured compound [16].

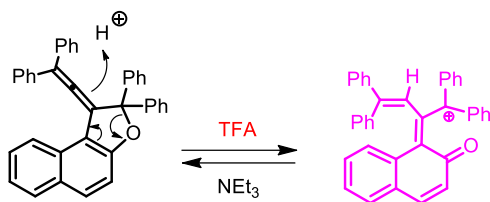

Scheme 2: Acidochromic behavior of vinylidene-naphthofurans

However, the opened coloured species has a cationic character and can undergo intramolecular reactions. We have observed that these species evolve slowly and irreversibly, at room temperature, into a new compound which is not photochromic. Since both the synthesis of the vinylidene-naphthofurans and this side reaction are promoted by acid, we made the hypothesis that the acid-catalyzed reaction of 2-naphthols with tetraphenylbut-2-yne-1,4-diols, performed at an higher temperature, could led directly to this new compound.

Results and Discussion

To check the foregoing hypothesis, the reaction between 2-naphthol **1a** and tetraarylbut-2-yne-1,4-diol **2a** was reproduced in CHCl_3 under reflux, in the presence of p -TsOH. H_2O . It led to the initial formation of the expected photochromic vinylidene-naphthofuran, which is progressively converted into new compounds, having the same polarity, but without any photochromic activity. In one hour, the reaction is complete. After column chromatography and recrystallization a yellowish product was obtained in good yield (87%). Spectroscopic analysis of the solid shows that it is a 2:1 mixture of two polycyclic aromatic compounds, that were assigned to the spiranic structure **3a**, joining a naphthofuran to an indene, along with the unexpected 7a,13a-dihydrodinaphthofuran **4a** (**Scheme 3**).

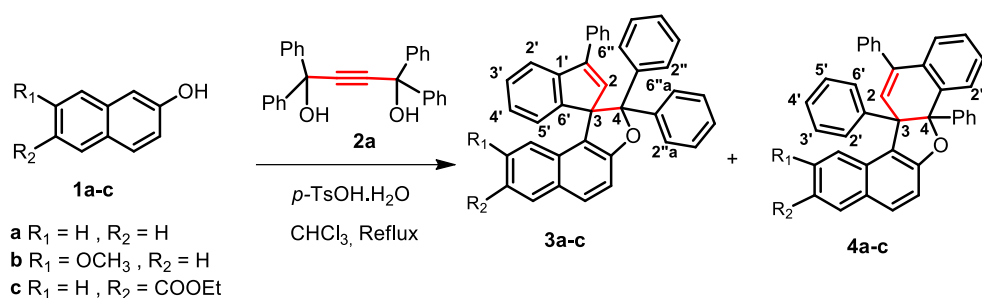

Scheme 3: Acid-catalyzed reaction of naphthols **1a-c** with tetraphenylbut-2-yne-1,4-diol **2a**.

The molecular structures of **3a** and **4a** were elucidated by NMR spectroscopy. For **3a**, 2D NMR COSY highlighted scalar correlations between protons $H_{2'}$ at 7.58 ppm, $H_{3'}$ at 7.17 ppm, $H_{4'}$ at 6.81 ppm and $H_{5'}$ at 6.57 ppm (**Figure 1**, see Supporting Information for full experimental data). In addition, long-range correlations in HMBC (**Figure 2**) between $H_{5'}$ (6.57 ppm) and H_2 (6.61 ppm) with the aliphatic quaternary carbon C_3 at 70.6 ppm and between protons $H_2, H_{2''=6''}$ (7.34 ppm), $H_{2''a=6''a}$ (7.49 ppm) and the sp^3 pyran carbon C_4 at 96.82 ppm proved the bond formation between carbons C_3 and $C_{6'}$ and are in agreement with the proposed structure.

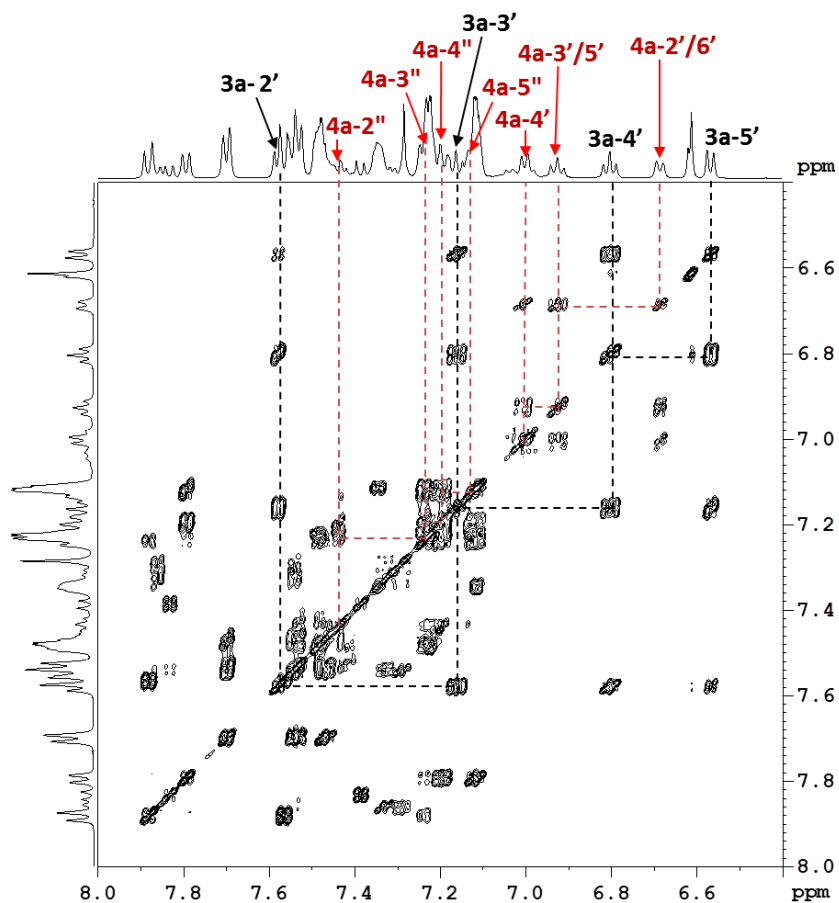

Figure 1: ¹H-¹H NMR COSY experiment of **3a** and **4a** in CDCl₃

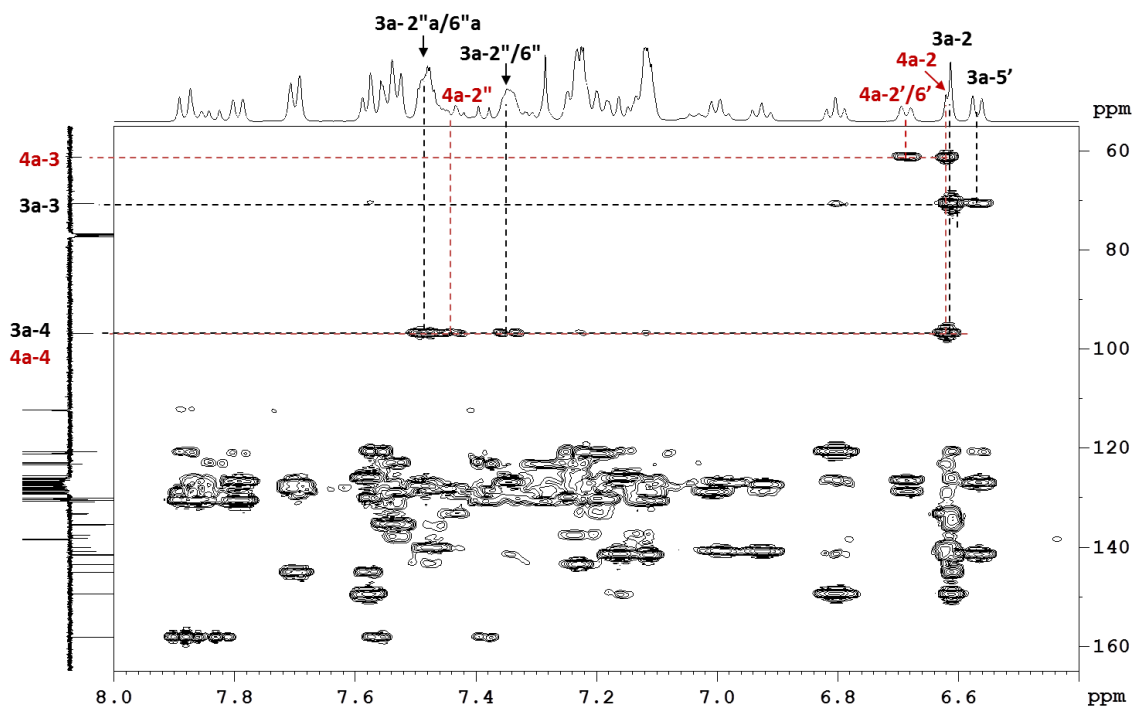
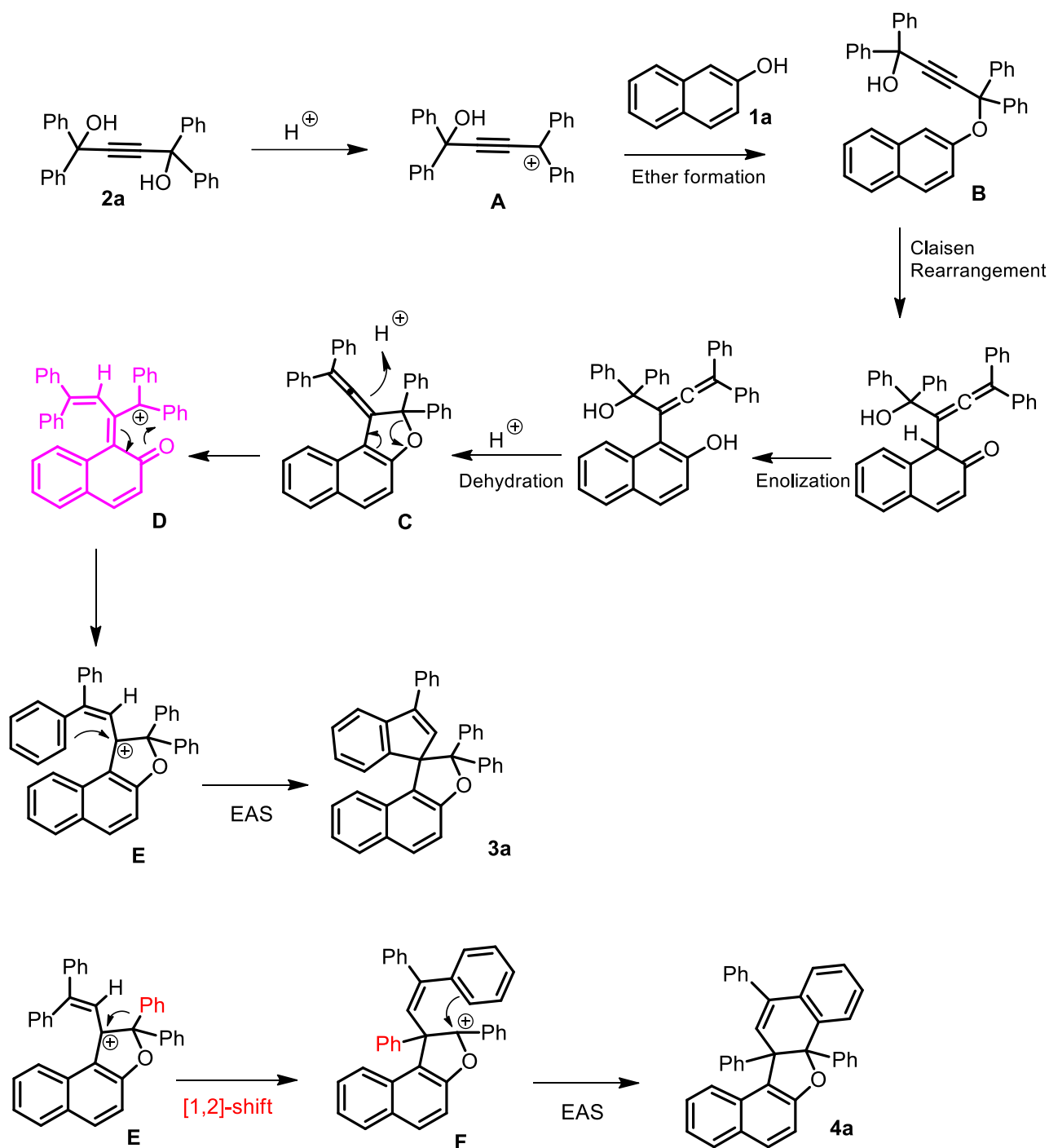

Figure 2: ¹H-¹³C NMR HMBC experiment of **3a** and **4a** in CDCl₃

For **4a**, the mono-substituted phenyl group attached to carbon C₃ was evidenced by the scalar correlations between protons H_{2'=6'} at 6.69 ppm, H_{3'=5'} at 6.93 ppm and H_{4'} at 7.00 ppm (**Figure 1**) and by the scalar ¹H-¹³C long-range correlations in HMBC, between protons H_{2'=6'} and H₂ at 6.62 ppm with the aliphatic quaternary carbon C₃ at 61.2 ppm. The sp³ pyran carbon C₄ at 96.79 ppm is also correlated through three bonds with protons H₂ and H_{2'} at 7.44 ppm (**Figure 2**).

The formation of the spiro compound **3a** and the fused naphthofuran **4a** can be explained by a series of cascade reactions [17]. Thus, under acid-catalysis the diol **2a** is converted into the propargylic carbocation **A**, which upon reaction with 2-naphthol **1a** provides the propargylic aryl ether **B**. This intermediate performs a [3,3]-sigmatropic Claisen rearrangement followed by enolization and acid-catalysed intramolecular dehydration affording the vinylidene-naphthofuran **C** detected as intermediate in this reaction [15]. Then, proton addition to the allene group followed by the opening of the dehydrofuran ring provides the coloured carbocation **D**. This species is then converted into the conjugated tertiary carbocation **E** which can perform an intramolecular electrophilic aromatic substitution reaction (EAS) giving the spiro[indene-1,1'-naphthofuran] **3a**, or an 1,2-aryl shift may occur in **E** providing the carbocation **F** which then performs an intramolecular electrophilic aromatic substitution, providing the polycyclic dinaphthofuran **4a** (**Scheme 4**).



Scheme 4: Proposed mechanism for the formation of the polycyclic spiroindene **3a** and dinaphthofuran **4a** from 2-naphthol **1a** and tetraphenylbut-2-yne-1,4-diol **2a**, under acidic conditions.

The same behavior was observed starting from substituted naphthols. Thus, the reaction of the diol **2a** with the commercially available 7-methoxynaphthol **1b** and ethyl 6-

hydroxy-2-naphthoate **1c** afforded the expected mixtures of the two corresponding polycyclic compounds **3b/4b** (40%, 1:0.8 mixture) and **3c/4c** (87%, 2:1 mixture) (**Scheme 3**). In HMBC experiments (**Figure 3**), the C₃ carbon in **3b/3c**, is observed at about 70 ppm with long range correlations with H_{5'} and H₂, whereas, in **4b/4c**, it is at about 60 ppm with long range correlations with H_{2'=6'} and H₂.

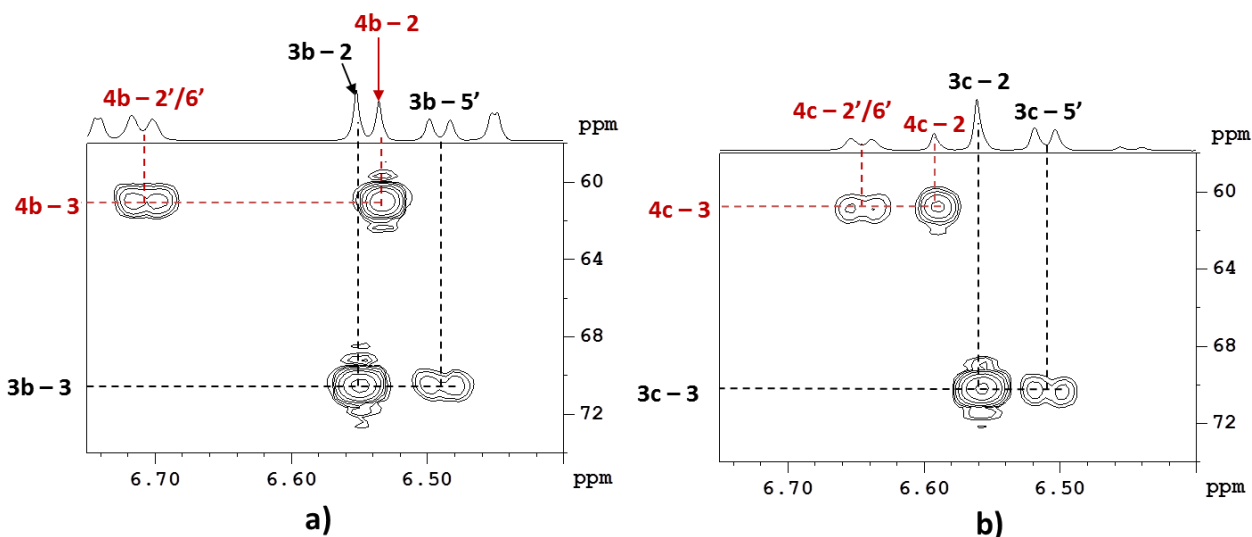
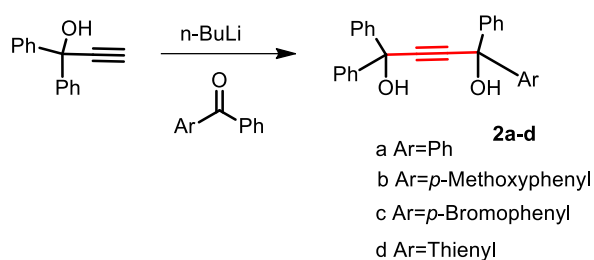

Figure 3: Part of HMBC experiments of a) **3b/4b** and b) **3c/4c** in CDCl₃

Since the presence of more reactive aromatic rings on the diol **2** could influence the selectivity of this domino reaction and favor the formation of the spiranic compound, three new diols **2b-d** were prepared through the reaction of 1,1-diphenylpropynol with n-BuLi followed by the addition of 4-methoxybenzophenone, 4-bromobenzophenone and thienyl phenyl ketone, respectively (**Scheme 5**). In fact, the reaction of 2-naphthol **1a** with methoxy substituted diol **2b** afforded mainly a 2:1 mixture of two spiranic compounds **3d/3d'** (70%) that differ on the position of the methoxy group (**Scheme 6**). In addition, a very weak amount of two isomers of dinaphthofuran is observed. The amount of each of them is around 5%.

The presence of the methoxy group creates an asymmetry in the diol **2b**. In this case the protonation of the diol should afford a carbocation **A** with the charge near the activated

aromatic ring. Therefore, according to the proposed mechanism (**Scheme 4**) this substituent should end in the phenyl group attached to the allene in the intermediate **C**. Then, after proton addition the carbocation **E** may be attacked by the phenyl or the methoxyphenyl rings affording mainly a mixture of the spirocompounds **3d/3d'** with the expected predominance of compound **3d**.



Scheme 5: Synthesis of tetraarylbut-2-yne-1,4-diols **2a-d**.

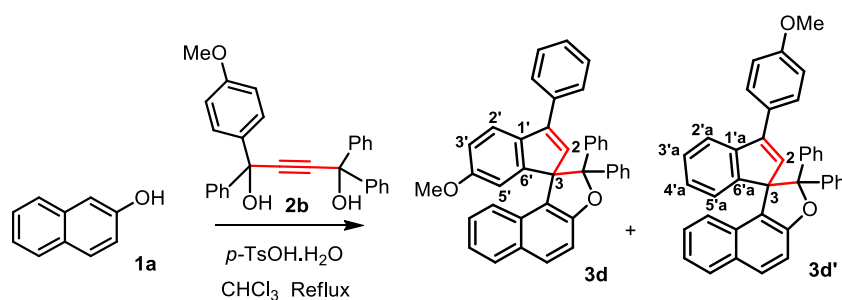

Scheme 6: Acid-catalyzed reaction of naphthol **1a** with the diol **2b**.

In the 2D-COSY experiment (**Figure 4**) the main spiranic isomer **3d** is identified by scalar coupling pattern between protons H_{5'} at 6.08 ppm, H_{3'} in the *meta* position at 6.71 ppm and H_{2'} at 7.47 ppm, formed after carbons C₃ and C_{6'} bond formation. The second isomer **3d'** is identified by scalar coupling pattern between protons H_{5'a} at 6.56 ppm, H_{4'a} at 6.79 ppm, H_{3'a} at 7.14 ppm and H_{2'a} at 7.57 ppm. The structures of the spiranic structures **3d** and **3d'** were confirmed in the HMBC experiment (**Figure 5**) by long range correlations between the carbons C₃ at about 70 ppm with protons H₂ and H_{5'} for **3d** and with protons H₂ and H_{5'a} for **3d'**. In this HMBC experiment, characteristic correlations between protons H₂

and protons H_{2=6'} with carbons C₃ at 60 ppm pointed also to the possible presence of two minor isomers of the dinaphthopyran derivatives **4d/4d'**.

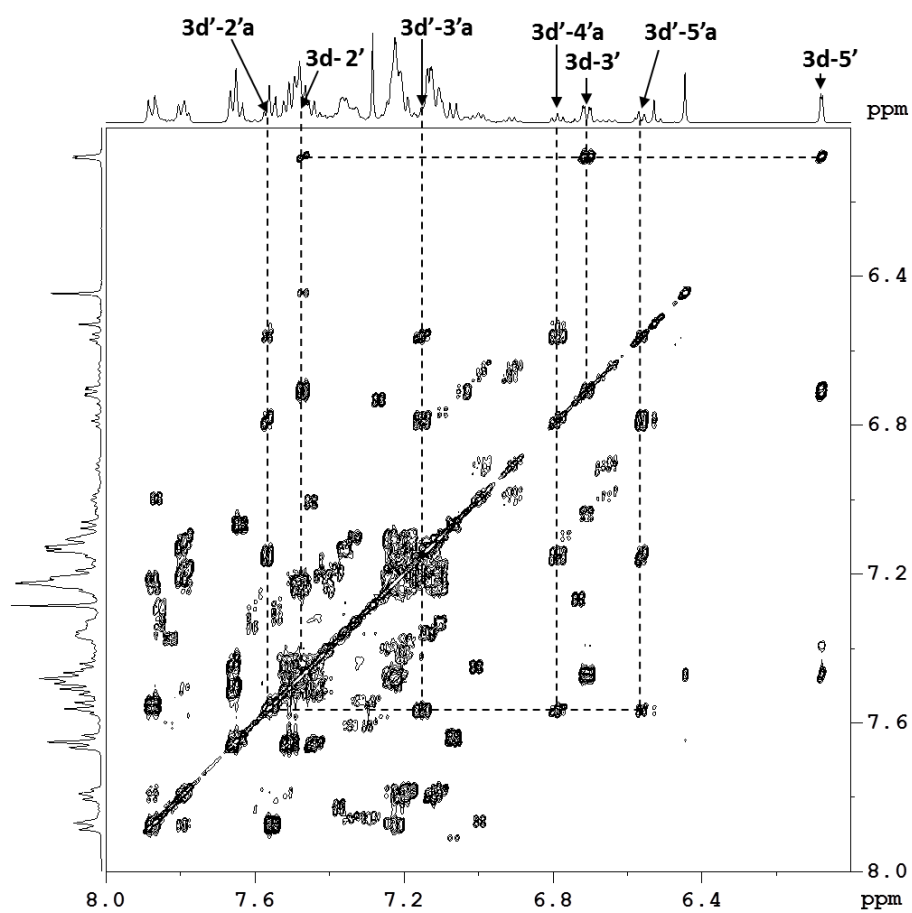

Figure 4: COSY experiment of **3d** and **3d'** in CDCl₃.

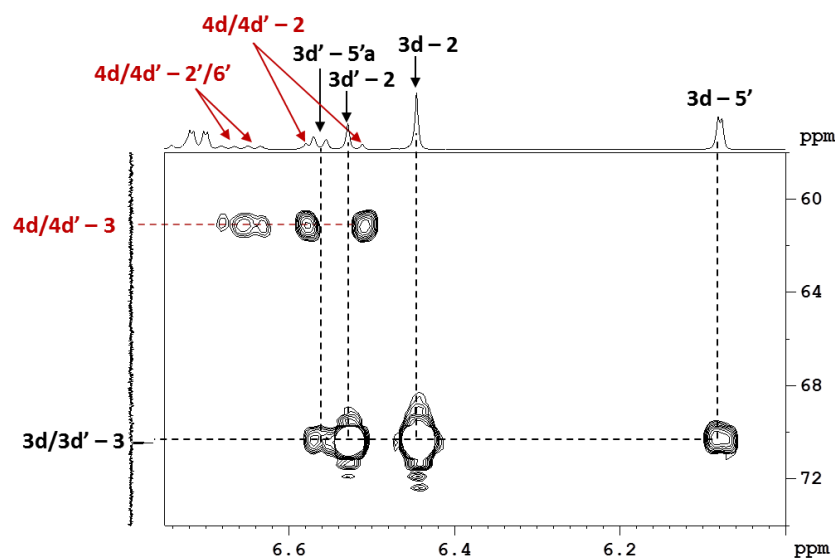
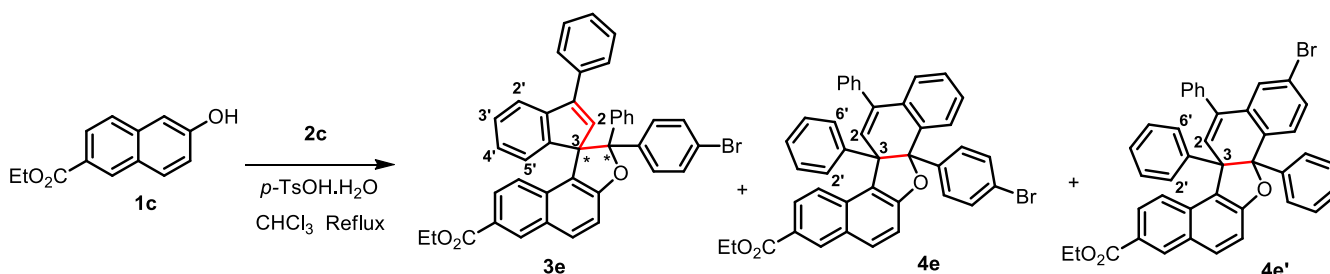

Figure 5: Part of HMBC experiment of **3d/3d'** and **4d/4d'** in CDCl_3 .

The presence of an electron withdrawing bromine atom in the diol **2c**, leads to a different reactivity. In this case the protonation of the diol **2c** should afford a carbocation with the charge far from the bromophenyl group. Therefore, according to the proposed mechanism, the bromine atom should appear in the phenyl group attached to the C-O sp^3 carbon atom in the intermediate **C** and end up in the C-O sp^3 phenyl groups of the spirocompound **3**. In fact the reaction of diol **2c** with the naphthol **1c** affords a complex mixture of 4 compounds (75% yield): two diastereoisomers of the spiranic structure **3e** (80%) along with two isomeric dinaphthofurans **4e/4e'** (20%) (**Scheme 7**).



Scheme 7: Acid-catalyzed reaction of naphthol **1c** with the diol **2c**.

In the 2D-COSY experiment (**Figure 6**) the two diastereoisomers of **3e** are identified by the splitting of the scalar coupling between protons H_{5'} at 6.49/6.57 ppm via H_{4'} at 6.81/6.86 ppm, H_{3'} at 7.18/7.20 ppm and H_{2'} at 7.59 ppm, indicative of the coupling between carbons C₃ and C_{6'}. In addition in the HMBC experiment (**Figure 7**) long range correlations between the carbons C₃ at about 70 ppm with protons H₂ and H_{5'} are observed. Moreover, the two minor isomers of the dinaphthopyran **4e** and **4e'** were identified by long range correlation with the carbons C₃ at about 60 ppm.

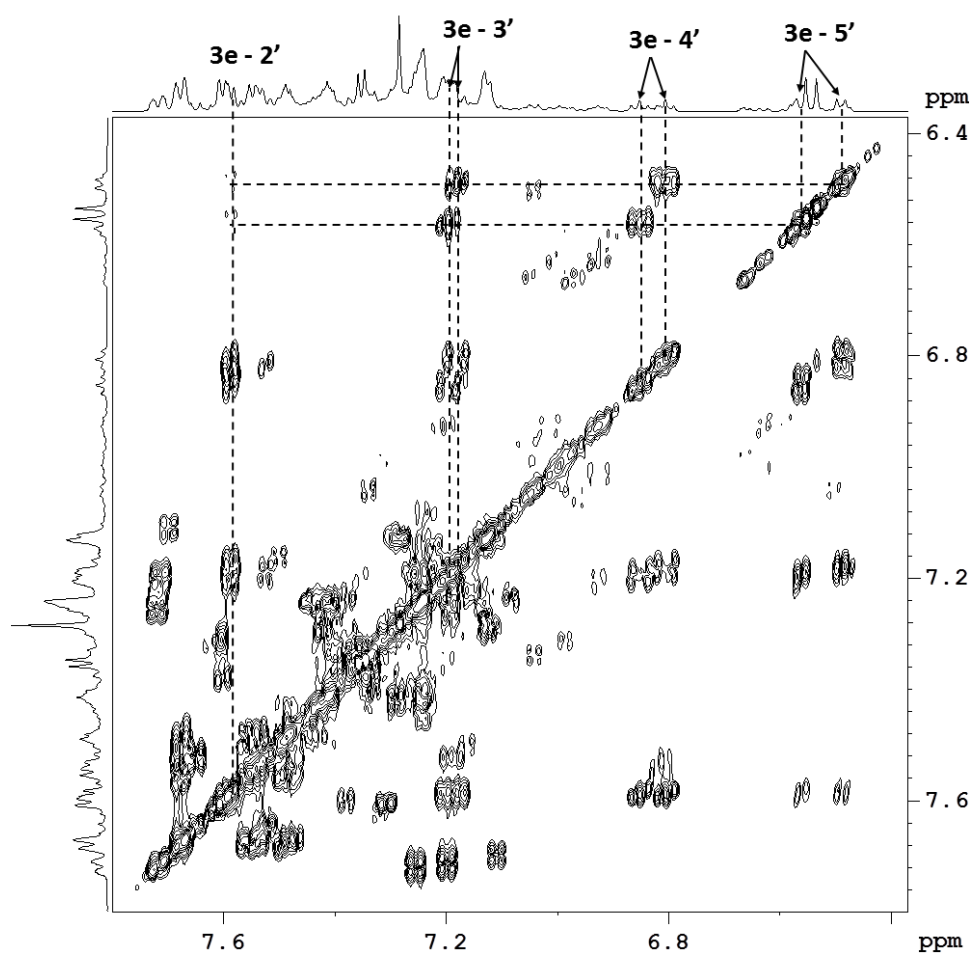

Figure 6: 2D-COSY experiment of **3e** in CDCl₃

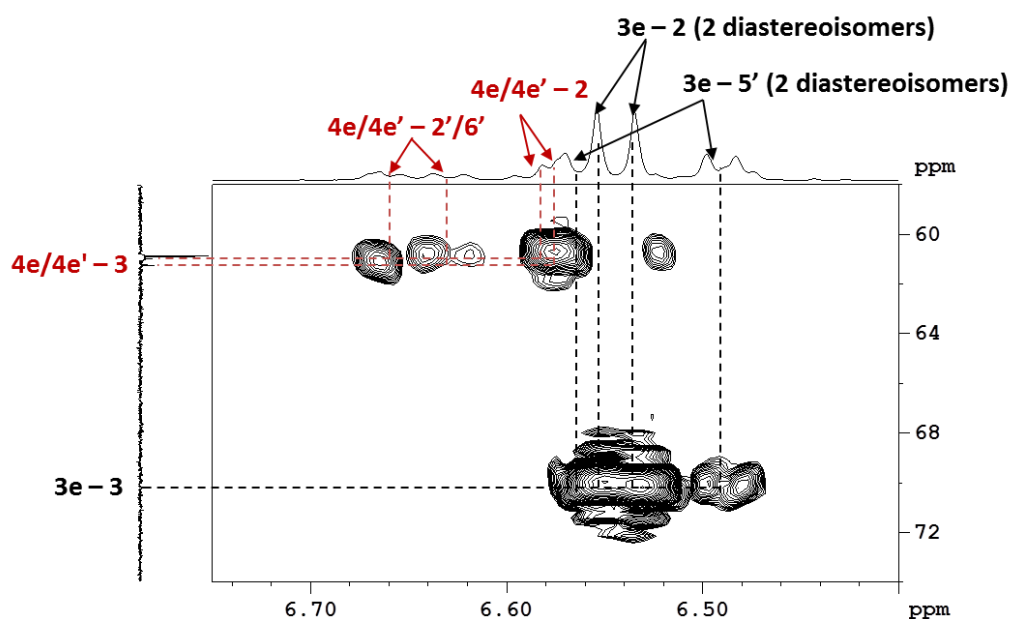
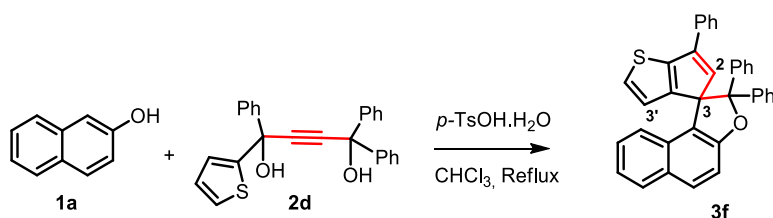

Figure 7: Part of HMBC experiment of **3e** and **4e/4e'** in CDCl_3 .

The use of the diol **2d**, presenting a thiophene ring, led to the formation of a unique product. In fact, heating a mixture of diol **1d** and 2-naphthol **1a** gave only the cyclopenta[b]thiophene spiranic compound **3f** (46% yield after column chromatography), due to the higher reactivity of the thiophene ring in the intramolecular electrophilic substitution reaction (**Scheme 8**).



Scheme 8: Acid-catalyzed reaction of naphthol **1a** with the diol **2d**.

In 2D HMBC experiment (**Figure 8**), the structure of **3f** was confirmed by long range correlations between the proton H_2 at 6.67 ppm with the aliphatic carbon C_3 at 69.0 ppm.

Due to the cyclization, a long range scalar coupling ${}^5J = 1.4$ Hz between proton H_2 and proton $H_{3'}$ at 7.00 ppm is observed.

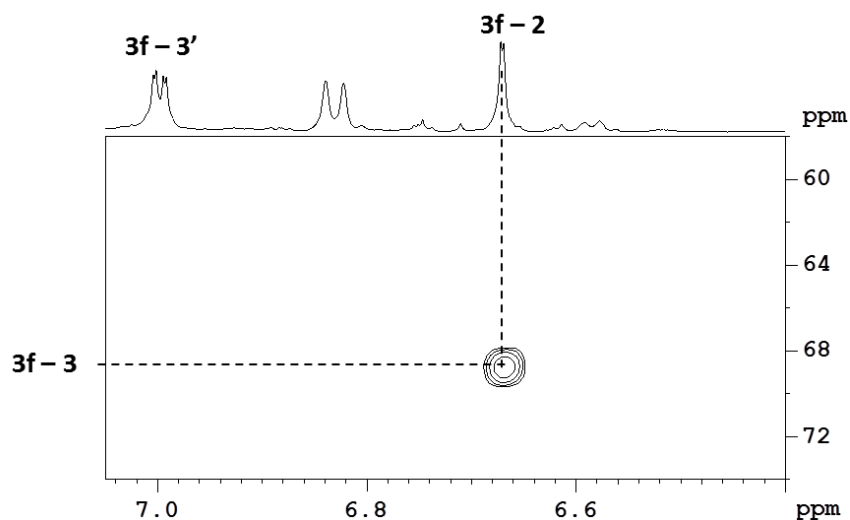

Figure 8: Part of HMBC experiment of **3f** in $CDCl_3$.

The formation of these polycyclic compounds by intramolecular cyclization of the coloured conjugated cation **D** (Scheme 4) may constitute a problem for the use of vinylidene-naphthofurans as photochromic molecules, due to fatigue under strong acidic conditions. However, this limitation may be overcome by the use of weaker acids, sufficient to observe the photochromic behavior of these molecules, at ambient temperatures. On the other hand, although the mixtures of spiroindenes **3** and dinaphthofurans **4** are quite difficult to separate, the formation of a single spiroproduct **3f**, using the more reactive thiophene ring in the diol, may open a way to the straightforward formation of cyclopenta[*b*]thiophene spiranic compounds which have structural resemblance with some pharmaceutical important molecules incorporating this motif [18-21].

Conclusion

The acid-catalysed reaction of 2-naphthols with tetraarylbut-2-yne-1,4-diols, performed under CHCl_3 reflux, affords a mixture of polycyclic naphthofuran derivatives whose structures were unambiguously established by 2D NMR analysis. The transformation occurs through a cascade of reactions involving the intermediate formation of vinylidene-naphthofurans which upon addition of one proton to the allene group affords a delocalized conjugated carbocation that undergoes two competitive intramolecular electrophilic reactions leading to the formation of two polycyclic isomeric compounds with spiroindene and dinaphthofuran structures. However, the use of thienyltriphenylbut-2-yne-1,4-diol leads to the formation of a single spiranic compound joining a cyclopenta[b]thiophene to a naphtho[2,1-*b*]furan.

Supporting Information

Supporting information features experimental procedures plus full spectroscopic data for diols **2a-c** and spiro compounds **3a-f/4a-e**.

Experimental Section

General remarks: All reaction were monitored by thin-layer chromatography on aluminum plates coated with Merck silica gel 60 F254 (0.25mm). IR spectra were obtained in a Shimadzu IRAffinity spectrometer using an ATR mode. Melting point were determined using a microscope URAC with a heating plate and are uncorrected. The ^1H and ^{13}C NMR spectra were recorded at 298K on a Bruker ARX 400 spectrometer (at 400.13 and 100.62 MHz). High resolution electrospray ionization time-of-flight (ESI-TOF) mass spectra and electron impact time-of-flight mass spectra were determined with a VG AutoSpec M spectrometer.

General Procedure for the Synthesis of diols 2a-d: n-Butyllithium (2 eq) was added dropwise to a solution of 1,1-diarylprop-2-yn-1-ol (2.5 g) in dry THF (30 mL) at 0°C. After complete addition, the cold mixture was maintained under constant stirring for 30 min. The adequate benzophenone (1.1 eq) was added at once to the solution, and the resulting mixture stirred at room temperature for 22 hours. The solvent was removed, water was added and the aqueous phase was extracted with ethyl acetate (3x30mL). The combined organic phases were dried (Na_2SO_4) and the solvent removed under reduced pressure to give an oil which was purified by recrystallization.

1,1,4,4-Tetraphenylbut-2-yne-1,4 diol 2a. 81%. Mp: 201.4–203.0 °C. IR (KBr, cm^{-1}): 3532, 3456, 3061, 3019, 2918, 2843, 2364, 2339, 1600, 1499, 1448, 1331, 1213, 1138, 1070, 1028, 995, 911, 886, 776, 743, 693, 642, 609. ^1H NMR (400 MHz, CDCl_3): 7.59 (d, $J = 7.9$ Hz, 8H), 7.39–7.23 (m, 12H), 2.86 (s, 2H, OH). EI-MS (TOF) m/z (%): 372 (32), 371 (11), 370 (14), 356 (28), 344 (22), 267 (22), 265 (27), 252 (11), 208 (10), 207 (14), 182 (64), 181 (10), 179 (13), 178 (17), 165 (19), 05 (100), 77 (50). HRMS calcd for $\text{C}_{28}\text{H}_{20}\text{O}$ ($M - \text{H}_2\text{O}$): 372.1514. Found: 372.1503.

1-(*p*-Methoxyphenyl)-1,4,4-triphenylbut-2-yne-1,4-diol 2b. 77%. Mp 107.5–109.5°C. IR (KBr, cm^{-1}): 3375, 1590, 1509, 1446, 1362, 1241, 1174, 996, 892, 839, 778, 691. EI-MS (TOF) m/z (%): 420 (M^+ , 0.18), 225 (31), 386 (100), 374 (28), 143 (47), 265 (31), 252 (26), 237 (26), 207 (14), 182 (14), 165 (38). ^1H NMR (400 MHz; CDCl_3): 7.59-7.50 (m, 6H), 7.35 (d, $J=7.1$ Hz, 2H), 7.32-7.26 (m, 9H), 6.85 (d, $J=8.6$ Hz, 2H), 3.79 (s, 3H, OCH_3), 3.03-2.90 (m, 2H). ^{13}C NMR (100 MHz; CDCl_3): 159.1, 144.8, 144.7, 137.0, 128.3, 128.7, 127.8, 127.7, 127.4, 126.0, 125.9, 113.6, 90.2, 89.8, 74.5, 74.2, 55.3. HRMS calcd for $\text{C}_{29}\text{H}_{24}\text{O}_3$: 420.1725, found: 420.1724.

1-(*p*-Bromophenyl)-1,4,4-triphenylbut-2-yne-1,4-diol 2c. 67%. Mp 116.8–118.8°C. IR (KBr, cm^{-1}): 3408, 1596, 1492, 1442, 1395, 1208, 1127, 1073, 1013, 986, 892, 818, 745, 691, 611. EI-MS (TOF) m/z (%): 450 (M^+ , 8), 436 (31), 434 (35), 347 (8), 276 (15), 267 (10), 265 (35), 263 (14), 207 (22), 189 (15), 184 (18), 182 (18), 178 (28), 165 (19), 105 (100). ^1H NMR (400 MHz, CDCl_3): 7.60-7.50 (m, 6H), 7.50-7.40 (m, 4H), 7.35-7.20 (m, 9H), 3.11 (s, 1H), 3.05 (s, 1H). ^{13}C NMR (100 MHz; CDCl_3): 144.5, 144.2, 143.8, 131.4, 128.4, 128.3, 128.0, 127.9, 127.8, 125.9, 125.8, 121.8, 90.3, 89.4, 74.5, 74.1. HRMS calcd for $\text{C}_{28}\text{H}_{19}\text{OBr}$ ($M-\text{H}_2\text{O}$): 450.0619, found: 450.0619.

1.4. 1-Thienyl-1,4,4-triphenylbut-2-yne-1,4 diol 2d. 18%. Mp 172.6–174.5°C. IR (KBr, cm^{-1}): 3509, 1596, 1489, 1449, 1342, 1215, 1073, 1027, 979, 912, 832, 778, 739, 698, 644. EI-MS (TOF) m/z (%): 378 (M^+ , 14), 362 (100), 350 (17), 285 (10), 273 (31), 271 (17), 239 (15), 213 (14), 184 (39), 152 (15), 110 (20), 105 (38). ^1H NMR (400 MHz; CDCl_3): 7.67-7.60 (m, 7H), 7.40-7.20 (m, 9H), 7.03 (m, 1H), 6.89 (m, 1H), 3.28 (s, 1H), 3.08 (s, 1H). ^{13}C NMR (100 MHz; CDCl_3): 149.9, 144.5, 143.9, 128.3, 128.2, 127.8, 126.6, 126.0, 125.7, 125.4, 89.3, 89.3, 74.6, 72.0. HRMS calcd for $\text{C}_{26}\text{H}_{18}\text{OS}$ ($M-\text{H}_2\text{O}$): 378.1078, found: 378.1083.

General procedure for the synthesis of the spirocompounds 3-4: To a solution of naphthol **1a-c** (100 mg) and tetraarylbut-2-yn-1,4-diol **2a-d** (1 eq) in CHCl_3 (5 mL) was added APTS (catalytic) and the mixture was heated under reflux. TLC examination indicated the initial formation of the less polar and photochromic vinylidene-naphthofuran. After 1-2.5 h at reflux TLC examination indicated the absence of the diol and naphthol and the formation of a non-photochromic compound with the same polarity as the intermediate vinylidene-naphthofuran. The solution was cooled to room temperature and the solvent removed under reduced pressure. The residual product was purified by column chromatography (silica, 0-5 % ethyl acetate/petroleum ether).

The reaction of 2-naphthol **1a** with diol **2a** afforded a mixture of spironaphthofuran **3a** and dihydrodinaphthofuran **4a**: 87%. IR (KBr, cm^{-1}): 2959, 1624, 1596, 1496, 1436, 1375, 1275, 1020, 972, 805, 768, 739, 698. EI-MS (TOF) m/z (%): 498 (M^+ , 100), 422 (21), 421 (63), 393 (12), 356 (15), 331 (33), 327 (22), 315 (60), 313 (59), 307 (41), 300 (15), 267 (16), 239 (25), 149 (26), 137 (69), 127 (55), 99 (28), 81 (22), 69 (73). HRMS calcd for $\text{C}_{38}\text{H}_{26}\text{O}$: 498.1984, found: 498.1987. For NMR details see the supplementary information.

The reaction of 7-methoxy-2-naphthol **1b** with diol **2a** afforded a mixture of spironaphthofuran **3b** and dihydrodinaphthofuran **4b**: 40%. IR (KBr, cm^{-1}): 2959, 1624, 1516, 1469, 1439, 1375, 1275, 1227, 1127, 1033, 972, 825, 751, 698. EI-MS (TOF) m/z (%): 529 (M^++1 , 28), 528 (M^+ , 100), 451 (35), 337 (17), 302 (20), 300 (17), 165 (17). HRMS calcd for $\text{C}_{36}\text{H}_{24}\text{OS}$: 528.2089. Found: 528.2072. For NMR details see the supplementary information.

The reaction of ethyl 6-hydroxy-2-naphthoate **1c** with diol **2a** afforded a mixture of spironaphthofuran **3c** and dihydrodinaphthofuran **4c**: 87%. IR (KBr, cm^{-1}): 2985, 1711, 1621,

1474, 1442, 1362, 1275, 1241, 1187, 1093, 1020, 946, 809, 751, 698. EI-MS (TOF) m/z (%): 571 ($M^{+}+1$, 38), 570 (M^{+} , 100), 493 (41), 379 (34), 315 (38), 313 (63). HRMS calcd for $C_{41}H_{30}O_3$: 570.2195. Found: 570.2180. For NMR details see the supplementary information.

The reaction of 2-naphthol **1a** with diol **2b** afforded a mixture of spironaphthofurans **3d/3d'**. 70%. IR (KBr, cm^{-1}): 2945, 1596, 1509, 1442, 1348, 1268, 1239, 1174, 1033, 979, 939, 812, 745, 698. EI-MS (TOF) m/z (%): 529 ($M^{+}+1$, 38), 528 (M^{+} , 100), 451 (42), 361 (34), 307 (43), 302 (52), 300 (33), 165 (39). HRMS calcd for $C_{36}H_{24}OS$: 528.2089. Found: 528.2078. For NMR details see the supplementary information.

The reaction of 2-naphthol **1a** with diol **2c** afforded a mixture of Spironaphthofuran **3e** and dihydrodinaphthofurans **4e/4e'**: 75%. IR (KBr, cm^{-1}): 2959, 1711, 1627, 1469, 1355, 1268, 1234, 1187, 1093, 1013, 972, 812, 745, 691. EI-MS (TOF) m/z (%): 650 ($M^{+}+2$, 62), 648 (M^{+} , 59), 573 (17), 493 (20), 457 (24), 403 (21), 375 (27), 359 (22), 313 (100), 300 (25), 265 (28), 165 (60). HRMS calcd for $C_{41}H_{29}O_3Br$: 648.1300. Found: 648.1274. For NMR details see the supplementary information.

The reaction of 2-naphthol **1a** with diol **2d** afforded the Spironaphthofuran **3f**. 46% IR (KBr, cm^{-1}): 2952, 1630, 1596, 1489, 1446, 1369, 1248, 1237, 1006, 939, 805, 751, 691. EI-MS (TOF) m/z (%): 505 ($M^{+}+1$, 31), 504 (M^{+} , 100), 427 (33), 337 (28), 321 (33), 319 (25), 307 (22), 186 (82), 105 (32). HRMS calcd for $C_{36}H_{24}OS$: 504.1548. Found: 504.1545. For NMR details see the supplementary information.

Acknowledgments

We acknowledge the FCT (Portugals Foundation for Science and Technology) and FEDER (program COMPETE) for financial support through research project POCI-01-0145-FEDER-016726 and PTDC/QEQQOR/0615/2014. The 300 and 500 MHz NMR facilities were funded by the Région Nord-Pas de Calais (France), the Ministère de la Jeunesse de l'éducation Nationale et de la Recherche (MJENR) and the Fonds Européens de Développement Régional (FEDER).

References

1. T.W. Christopher, T. Yi, In *Natural Product Biosynthesis: Chemical Logic and Enzymatic Machinery*. Royal Society of Chemistry. London, **2017**.
2. D.J. Tantillo, *J. Phys. Org. Chem.* **2008**, *21*, 561-570.
3. H. Li, Y. Sun, Q. Zhang, Y. Zhu, S.M. Li, A. Li, C. Zhang, *Org Lett.* **2015**, *17*(2), 306-9.
4. B.T. Ueberbacher, M. Hall, K. Faber, *Nat. Prod. Rep.* **2012**; *29*(3), 337-50.
5. E.R. Strieter, A. Koglin, Z.D. Aron, C.T. Walsh, *J. Am. Chem. Soc.* **2009**, *131*(6), 2113-5.
6. J. Bai, D. Yan, T. Zhang, Y. Guo, Y. Liu, Y. Zou, M. Tang, B. Liu, Q. Wu, S. Yu, Y. Tang, Y. Hu, *Angew. Chem.* **2017**, *129*, 4860-4864.
7. B. Baskar, P. Dakas, K. Kumar, *Org. Lett.* **2011**, *13* (8), 1988-1991.
8. M. Ohashi, F. Liu, Y. Hai, M. Chen, M.C. Tang, Z. Yang, M. Sato, K. Watanabe, K. N. Houk, Y. Tang, *Nature* **2017**, *549*, 502-506.
9. K.C. Nicolaou, J.S. Chen, *Chem. Soc. Rev.* **2009**, *38*, 2993-3009.

10. K.C. Nicolaou, D.J. Edmonds, P.G. Bulger, *Angew. Chem. Int. Ed.* **2006**, *45*, 7134-7186.
11. C. Grondal, M. Jeanty, D. Enders, *Nat. Chem.* **2010**, *2*(3), 167-178.
12. L.F. Tietze, A. Modi, *Med. Res. Rev.* **2000**, *20*(4), 304-22.
13. S.B. Jones, B. Simmons, A. Mastracchio, D.W.C. MacMillan, *Nature* **2011**, *475*, 183-188.
14. T. Broja, P.J.W. Fuchs, K. Zeitler, *Nat. Chem.* **2015**, *7*, 950-951.
15. C. M. Sousa, J. Berthet, S. Delbaere, P.J. Coelho, *J. Org. Chem.* **2013**, *78*, 6956-6961.
16. C. M. Sousa, J. Berthet, S. Delbaere, P.J. Coelho, *Dyes Pigm.* **2017**, *137*, 593-600.
17. C. M. Sousa, J. Berthet, S. Delbaere, P.J. Coelho, *J. Org. Chem.* **2013**, *79*, 5781-5786.
18. J. Schripsema, G.P. Caprini, R. van der Heijden, R. Bino, R. de Vos, D. Dagnino, *J. Nat. Prod.* **2007**, *70*, 1495-1498.
19. N. Watanabe, H. Nakagawa, A. Ikeno, H. Minato, C. Kohayakawa, J. Tsuji, *Bioorganic Med. Chem. Lett.* **2003**, *13*, 4317-320.
20. N. Watanabe, A. Ikeno, H. Minato, H. Nakagawa, C. Kohayakawa, J. Tsuji, *J. Med. Chem.* **2003**, *46*, 3961-3964.
21. T.A. Blizzard, J.D. Morgan, R.T. Mosley, E.T. Birzin, K. Frisch, S.P. Rohrer, M.L. Hammond, *Bioorganic Med. Chem. Lett.* **2003**, *13*, 479-483.