



**HAL**  
open science

## Energy management of storage systems based power sources and loads

Benoit Robyns, Arnaud Davigny, Christophe Saudemont

► **To cite this version:**

Benoit Robyns, Arnaud Davigny, Christophe Saudemont. Energy management of storage systems based power sources and loads. International Symposium on Advanced Electromechanical Motion Systems, 2013, International Symposium on Advanced Electromechanical Motion Systems, 20 (1-4), pp.25-35. hal-04443876

**HAL Id: hal-04443876**

**<https://hal.univ-lille.fr/hal-04443876v1>**

Submitted on 7 Feb 2024

**HAL** is a multi-disciplinary open access archive for the deposit and dissemination of scientific research documents, whether they are published or not. The documents may come from teaching and research institutions in France or abroad, or from public or private research centers.

L'archive ouverte pluridisciplinaire **HAL**, est destinée au dépôt et à la diffusion de documents scientifiques de niveau recherche, publiés ou non, émanant des établissements d'enseignement et de recherche français ou étrangers, des laboratoires publics ou privés.

# Energy management of storage systems based power sources and loads

B. Robyns, A. Davigny, C. Saudemont

University of Lille Nord of France, University of Lille 1, Laboratory of Electrical Engineering and Power Electronics of Lille (L2EP), Ecole des Hautes Etudes d'Ingénieur (HEI), 13 rue de Toul, 59046 Lille France.

*Abstract*— This paper discusses about the management of storage systems and loads which can offer some storage capacities. A methodology based on fuzzy logic is presented in this paper and is applied at different practical cases: variable speed wind generator associated with a flywheel energy storage system, energy management strategy for commercial building and finally, coordinated integration of electric vehicle and wind power in electrical network.

## I. INTRODUCTION

Due to the development of renewable energy sources, the future development of new kind of loads like electrical vehicles and the electricity market liberalization, electrical networks are changing rapidly to meet the following requirements:

- Significant increase in dispersed sources with irregular operating conditions.
- Increased requirements in terms of energy efficiency and reliability of electricity supply.
- Future requirement of “natural” integration in the electricity market for Renewable Energy.
- Demand management of electricity.

The transmission and distribution of electrical energy are concerned, but also to varying degrees internal networks in industrial units and buildings, as well as specific network of transport systems and embedded systems. The trend towards smart grids in order to satisfy in an optimal way the above requirements can be contradictory.

Energy storage enables us to compensate the random variations of the production of renewable origin (mainly wind and photovoltaic energy), in order to ensure an available power level. This storage can provide various services, which will depend on its positioning in electric networks.

There are two possibilities for the development of storage in electric networks:

- leaned on large intermittent production units (e.g. hydraulic storage associated with wind power connected to the transport network);
- diffused, i.e. distributed in the distribution network for example.

To make storage profitable, one of the approaches consists of pooling the services that can be provided by a storage system for various actors (operators, producers, consumers, etc.) [1-4]. These services are as follows:

- Local fine and dynamic voltage control;
- Support of the network in degraded operation;
- Return of voltage in network parts;
- Reactive compensation for network managers (and customers);
- Reduction of transport losses;
- Power quality;
- Energy postponement and support to the existing farm;
- Primary frequency control and frequency stability of the insular grids;
- Solving congestion;
- Supporting the participation in ancillary services;
- Erasure recovery;
- Guarantee of a production profile;
- Peak smoothing;
- Consumption postponement;
- Supply quality/continuity.

Controlling the power demand will enable more efficient use of electric networks, but also in some cases, a better adequacy between consumption and the production characteristics of decentralized sources.

Fig. 1 shows the typical profiles of domestic and commercial consumers. They illustrate the variable nature of consumption according to the hour of the day, the season and the type of load. Controlling the power demand fulfills the objective of moving, in time, the consumption of some loads to the moment when the production from renewable energy is available, if possible locally; but also to organize the hourly consumption, in order to better use the electric network, by preventing, for example, the congestion of some lines of the network.

In France, buildings absorb 43% of the total consumed energy. This is thus a significant issue, aiming to reducing the consumption of buildings, in order to obtain zero consumption buildings or production buildings (negative consumption or positive energy buildings). The expression “positive energy building” must be understood as a building that throughout the year has lower energy consumption than its production.

Nevertheless, positive energy buildings can sometimes have consumption higher than the production and must therefore resort to the network to maintain a supply demand balance on a building scale. This objective of positive energy building will require, amongst other things, a massive integration of renewable energies into these buildings, probably the addition of energy storage means and a “smart” management of the energy [5-8].

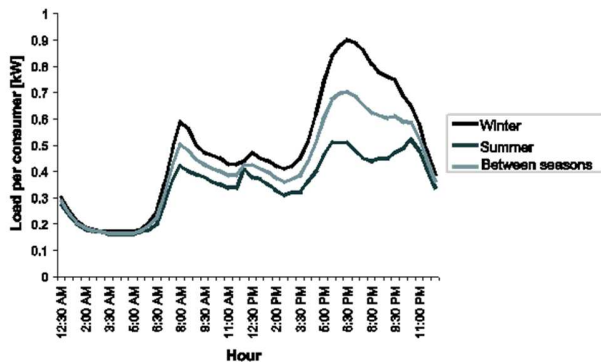

Fig. 1. Typical profiles of domestic consumers without electric heating [1].

The massive swing of the fleet of private cars to plug-in hybrid and or entirely electric (batteries) vehicles will have a significant impact on electric networks. These vehicles are specific loads, whose recharging could be optimized by taking into account the load state of the network, the necessary speed for recharging and the availability of decentralized production sources. These vehicles will be if possible smart loads and storage systems, whose management coupled with that of positive energy buildings seem relevant for the future. By 2020, the fleet of electric and hybrid vehicles is estimated to contain about 2 million units in France [9,10].

Railway traffic increases and electricity market liberalization constrain the railway actors to consider new solutions to handle the energy consumption. Hence, a technology change in the railway electrical systems is considered through the integration of renewable energy sources and storage units [11,12].

This paper discusses about the management of storage systems and loads which can offer some storage capacities. A methodology based on fuzzy logic is presented in this paper and is applied at different practical cases:

- Variable speed wind generator associated with a flywheel energy storage system;
- Energy management strategy for commercial building;
- Coordinated integration of electric vehicle and wind power in electrical network.

## II. STORAGE ENERGY MANAGEMENT

Energy management of energy storage is a major challenge due to the complexity of the problem to be treated, high economic and ecological issues, and that management methodology to achieve the objectives is not unique [13,14,15].

Different levels of network supervision may be

distinguished function of the time scale considered:

- Long term supervision which corresponds to a time scale of one day;
- Medium term supervision which corresponds to a time scale of roughly one hour or a half hour;
- And the real time supervision which is more particularly considered in this paper.

The challenges to achieve the objectives mentioned in the introduction are:

- Develop technical supervision of electrical systems whose condition or behavior is poorly known (random), whose time horizons to include can be very short (real time to respond to dynamic loading) and long (such as a year to take into account the seasonal nature of renewable sources).

- Develop multi storage approaches.
- Develop a multi objective supervision and pooling services.

Three methodologies to supervise in real time storage systems units can be usually considered [15]:

- Causal methodology based on power flow inversion allowing determining reference powers. This method needs detailed model and a good knowledge in real time of the power flows and the associated losses [7,16-19]. These methods become difficult to implement in real time for large size systems;

- Explicit methodology based on objective functions and optimization methods, which explicitly determine the maximum or the minimum of a function [10,11,20]. This approach is difficult to achieve in real time, and are not easily usable when the time horizon of study must extend over a year to take into account the seasonal nature of some renewable sources, and when must be considered systems whose state depends on time, as storage;

- Implicit methodology based on artificial intelligence tools, like fuzzy logic supervisor [21-26] or multi-agent systems [27], for instance. Fuzzy logic is a well-adapted tool to manage complex Hybrid Energy Sources because of the difficulty to obtain or to use precise models of these systems, and the difficulty to predict the behavior of the wind or the sun, the state of the electrical grid, load consumptions or the trajectory of some transport systems [28,29].

In practice, a mix of these methodologies is generally optimal.

Currently, to design the control of a complex system in industrial applications, two graphical tools are used; Petri nets [30,31] and grafsets [32]. These tools enable to build graphically and step by step the control system so as the analysis and the implementation of control functions are easier. They are well suited for sequential logical systems. However, they are not well adapted for hybrid production units, which include random and continuous variables.

The proposed graphical methodology in [15,23] is an extension of this graphical approach to include fuzzy and unknown data. The proposed method allows:

- The avoidance of detailed and elaborate models of the different sources and storage systems,
- A systematic determination of a multi objectives

supervisor,

- Smoothed transitions between the different states of the hybrid system,
- The minimization of the number of fuzzy rules and then the simplification of the real time implementation.

To develop the supervision, different steps are considered [23]:

- First, determination of the system work specifications: definition of the objectives, constraints and action means;
- Second step, the structure of the supervisor must be designed and then all the inputs and outputs must be determined;
- Third step, determination of the main operating modes with the help of functional graphs;
- Fourth step, determination of the membership functions of all input and output variables;
- Fifth step, determination of the fuzzy operating modes with the help of operational graphs;
- Sixth step, determination of the fuzzy rules;
- Seventh step, determination of indicators to measure the achievement of objectives;
- Eighth step, Experimental Design Methodology and Genetic Algorithms are used to tune parameters suitable for a fuzzy supervisor to optimize power, energy, efficiency, voltage quality, economic or environmental indicators [33-41].

This method allows us to consider only the interesting rules to limit the complexity of the supervision. The last optimization step can be extended to the design of physical parameters of the storage system like power and energy [42]. The proposed approach has the particularity to integrate all the supervision strategy and the dynamics of the system, while the optimization step considers often simplified models and energy management to reduce the computation time which may increase rapidly. Classical explicit methodologies are then used to make a pre-design of the system [11].

Different examples will illustrate the different steps of the proposed methodology.

### III. VARIABLE SPEED WIND GENERATOR ASSOCIATED WITH A FLYWHEEL ENERGY STORAGE SYSTEM

In variable speed wind generator (VSWG) based on a permanent magnet synchronous generator, the flywheel energy storage system (FESS) may be connected to the DC bus as shown in Fig. 2 [43-48]. Different objectives to manage the storage system have been considered [15,47]. The proposed supervision strategy has been tested on a 3 kW laboratory test bench [46].

It would be possible to determine the reference power of the storage system only with the help of a controller which control the DC bus voltage. But in this case, the energy storage level is not considered. Moreover, the information about the wind power we want to smooth is not used. A fuzzy logic supervisor has been proposed in [46]. The application of the proposed methodology to design the supervisor gives the following steps.

Step 1 - The first step is to determine the objectives of the supervisor, the constraints of the systems and the means of action. Different tools are also defined. Table 1 summarizes the data in this case.

TABLE 1  
SUMMARY TABLE FOR THE DEVELOPMENT OF SUPERVISOR

Objectives	Constraints	Means of action	Tools
Smoothing of the power sent to the network.	Storage capacity is limited	Reference of the power sent to the grid : $P_{reg}$	Low-Pass filter
Storage availability.	Low and high limits of the storage		Fuzzy Logic
Maintaining the DC bus voltage.	Voltage reference value	Reference of the power of the storage : $P_{SISE\_ref}$	PI Controller

Step 2 - The structure of the supervisor is shown in Fig. 3. Inputs depend on the objectives: the voltage  $U_{DC}$  of the DC bus, the power of the wind generator  $P_{wg}$ , and the speed of rotation of the flywheel,  $\Omega$ . The outputs consist of the two means of action, the power to store or to generate by the storage system  $P_{FESSref}$  and the power to generate into the network  $P_{reg}$ . The tools used are a low-pass filter, a Proportional Integral corrector, and then the fuzzy logic, in order to take into account the speed of the flywheel in the determination of the power supplied to the network.

Step 3 - The fuzzy supervisor has two inputs (the rotational speed of the flywheel, the state of charge of the storage, and the low frequency component of the wind power) and one output, which is the reference power to send to the grid. Functional graphs determine the trend of the power returned to the grid,  $P_{reg}$ , depending on the state of charge of the storage and the wind power supplied.

The operating states of the first level N1 are indicated on the graph in Fig. 4:

- If the storage level is SMALL, the system has to ensure the storage availability (N1.3),
- If the storage level is BIG, the system has to ensure the storage capacity, which consists in avoiding the saturation of the storage (N1.2),
- If the storage level is MEDIUM, no special action is considered about storage (N1.1).

Each sub-level is then developed, as shown in Fig. 5, for N1.2 level. The N1.1 level corresponds to a system operation when the storage is charged at a MEDIUM level. No action in terms of charging or discharging is favored in storage. The trend is to send to the grid the wind power supplied by the generator.

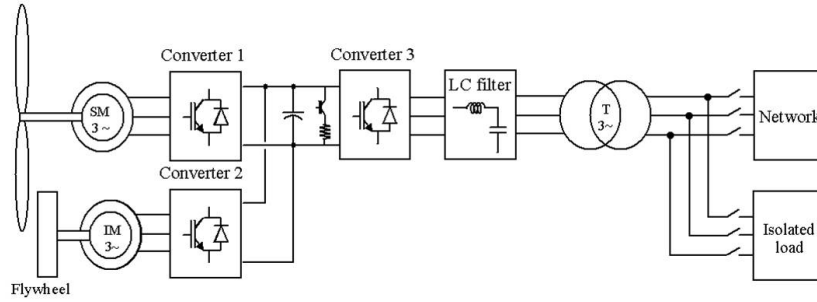

Fig. 2. VSWG-FESS assembly under study [46].

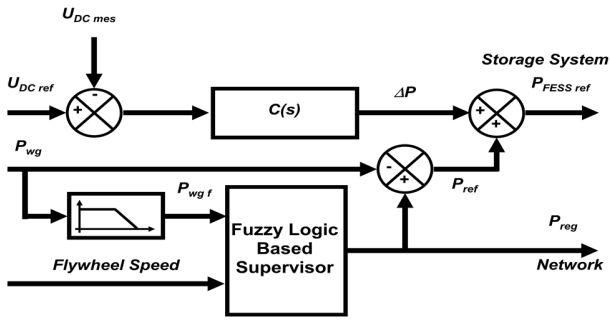

Fig. 3. Supervision strategy of the VSWG-FESS assembly.

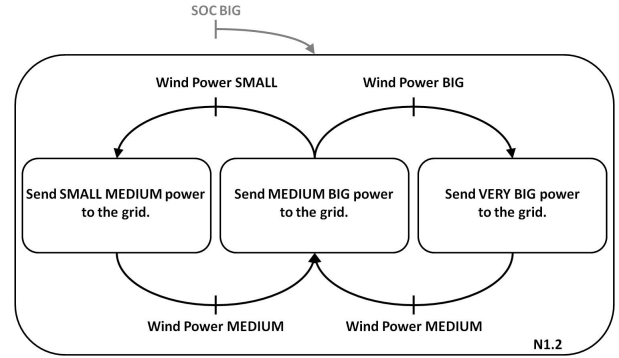

Fig.6. Functional graph N1.2.

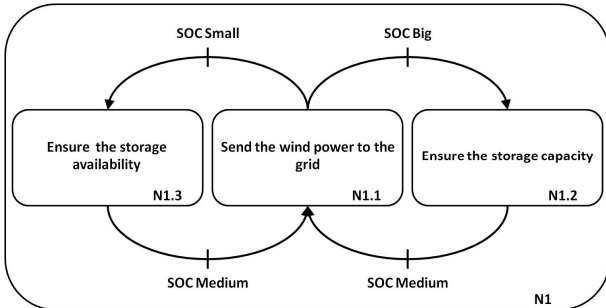

Fig. 4. Functional graph N1.

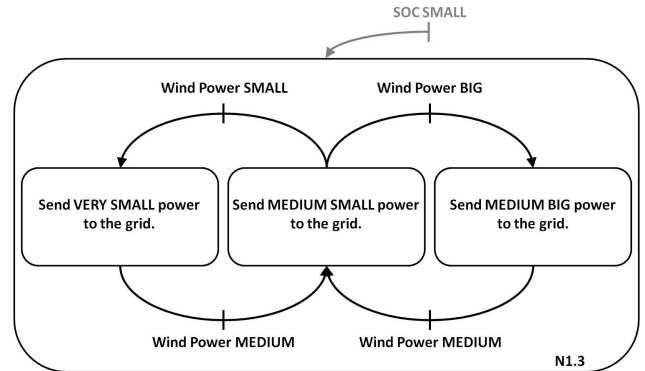

Fig.7. Functional graph N1.3.

The other two levels, N1.2 and N1.3 are developed in the same way, leading to the graphs in Fig. 6 and 7, respectively for BIG and SMALL State Of Charge conditions.

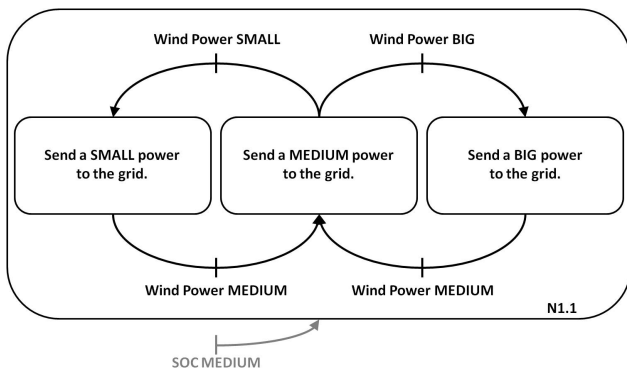

Fig.5. Functional graph N1.1.

Step 4 - For each input variable (Flywheel speed and wind generator power), the number of fuzzy sets is chosen equal to 3 (Fig. 8 and 9), compromise between accuracy and limitation of the number of fuzzy rules. The three membership functions are chosen empirically, trapezoidal and symmetrical about the center of the universe of discourse. The output variable uses seven membership functions, for reasons of accuracy (Fig. 10). The linguistic labels used are summarized in the table 2.

Step 5 - Operational graph shown in Fig. 11, are determined from the previous functional graphs and the membership functions developed in the step 4.

Step 6 - According to the operational graphs, the fuzzy rules can be established, as indicated in the table 3.

The Fig. 12 shows the output of the fuzzy logic supervisor: the reference power to generate into the network, in function

of the wind generator power and the flywheel speed. This output surface is nonlinear. The real time implementation of the fuzzy logic needs often a significant computation time. This was the reason for searching a simplified supervisor in order to reduce this computation time. The first proposed approximation is a plan chosen in order to keep the corners of the fuzzy logic surface [46].

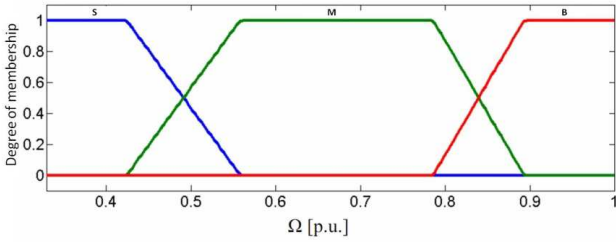

Fig. 8. Flywheel speed  $\Omega$  - Membership functions.

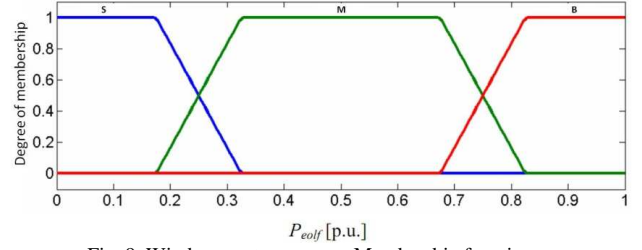

Fig. 9. Wind generator power – Membership functions.

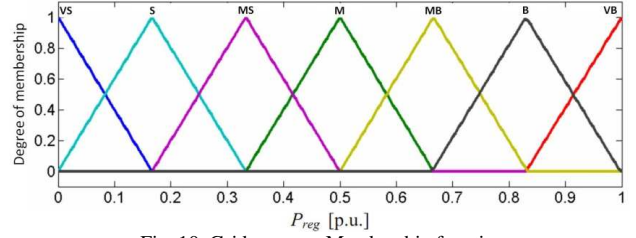

Fig. 10. Grid power – Membership functions

TABLE 2

LINGUISTIC LABELS AND SIMPLIFICATIONS

Linguistic labels	VERY SMALL	SMALL	MEDIUM SMALL	MEDIUM	MEDIUM BIG	BIG	VERY BIG
Linguistic labels simplified	VS	S	MS	M	MB	B	VB

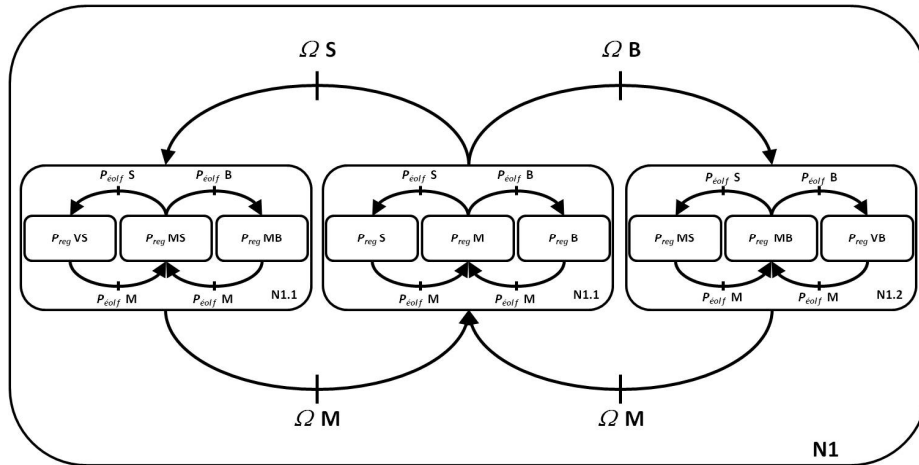

Fig. 11. Operational graph.

TABLE 3  
FUZZY RULES

N1	N1.1	IF $\Omega$ M	AND IF $P_{éol f}$ M	THEN $P_{reg}$ M
		IF $\Omega$ M	AND IF $P_{éol f}$ B	THEN $P_{reg}$ B
		IF $\Omega$ M	AND IF $P_{éol f}$ S	THEN $P_{reg}$ S
	N1.2	IF $\Omega$ B	AND IF $P_{éol f}$ M	THEN $P_{reg}$ MB
		IF $\Omega$ B	AND IF $P_{éol f}$ B	THEN $P_{reg}$ VB
		IF $\Omega$ B	AND IF $P_{éol f}$ S	THEN $P_{reg}$ MS
	N1.3	IF $\Omega$ S	AND IF $P_{éol f}$ M	THEN $P_{reg}$ MS
		IF $\Omega$ S	AND IF $P_{éol f}$ B	THEN $P_{reg}$ MB
		IF $\Omega$ S	AND IF $P_{éol f}$ S	THEN $P_{reg}$ VS

The Fig. 12 shows the output of the fuzzy logic supervisor: the reference power to generate into the network, in function of the wind generator power and the flywheel speed. This output surface is nonlinear. The real time implementation of the fuzzy logic needs often a significant computation time. This was the reason for searching a simplified supervisor in order to reduce this computation time. The first proposed approximation is a plan chosen in order to keep the corners of the fuzzy logic surface [46].

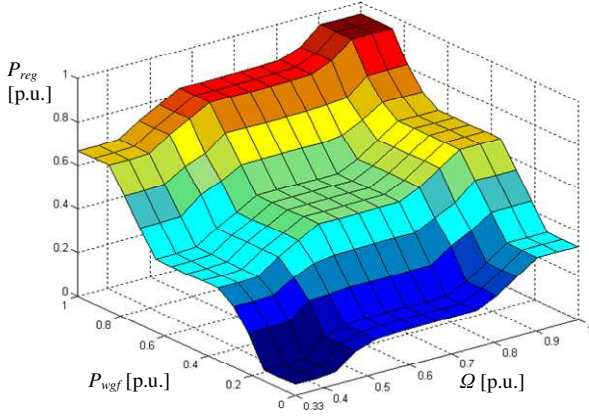

Fig. 12. Output surface of the fuzzy-logic supervisor.

In Fig. 13, experimental results show the power generated into the grid, which is smoothed in comparison with the power generated without storage system (Fig. 14), and the flywheel speed which corresponds to the storage level. The storage system does not saturate. In this case the flywheel speed is limited between 1000 and 3000 rpm.

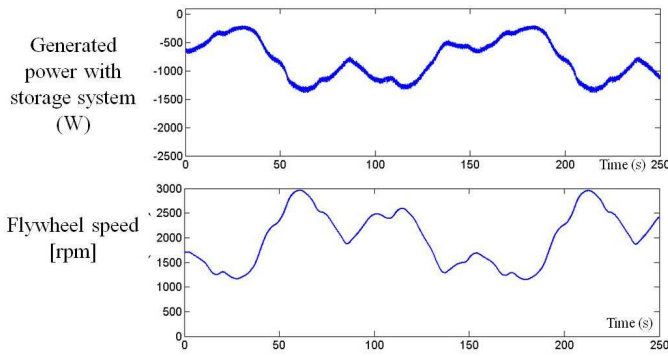

Fig. 13. Power delivered into the grid, with FESS, and flywheel speed with a plan based supervisor.

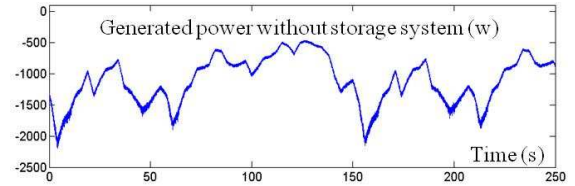

Fig. 14. Power delivered into the power network, without FESS.

#### IV. ENERGY MANAGEMENT STRATEGY FOR COMMERCIAL BUILDING

This case concerns an energy management strategy for a commercial building, in which economic considerations have been integrated [5]. Several topologies of the grid connected commercial building are presented in [49,50]. Fig. 15 shows the configuration of the system under study. Photovoltaic panels and a storage system are installed in parallel with the supermarket loads. The supervision strategy manages the storage system.

The objectives, constrains and means of action to design the supervision strategy are specified in table 4.

Fig. 16 shows a chart representation of the proposed fuzzy logic supervision. Three pricing period have to be considered. In each pricing period, there are different operating modes with different transition conditions [5].

Indicators (step 7 in the methodology described in section II) have been defined to measure the achievement of the objectives. Based on simulation results, table 5 allows us to compare for a 13000 square meter supermarket, the annual premium in €, the one week consumption in € and the CO<sub>2</sub> emissions, without (case 1) and with photovoltaic panels and storage systems (case 2). With photovoltaic panels and storage system, the annual premium is reduced by 29%, the consumption is reduced by 31% and CO<sub>2</sub> emissions are reduced by 26%. These values do not take into account the investment costs.

Fig. 17 shows the comparison of CO<sub>2</sub> emissions for a period of one week for both cases. The curve in full line shows the evolution of the CO<sub>2</sub> emissions when photovoltaic panels and storage system are integrated in the supermarket. This curve is generally lower than the curves in broken line which correspond to the actual situation. The estimation of the CO<sub>2</sub> emissions is based on the realized production of the French Transmission System Operator and the CO<sub>2</sub> emissions estimated for each kind of production unit [51,52].

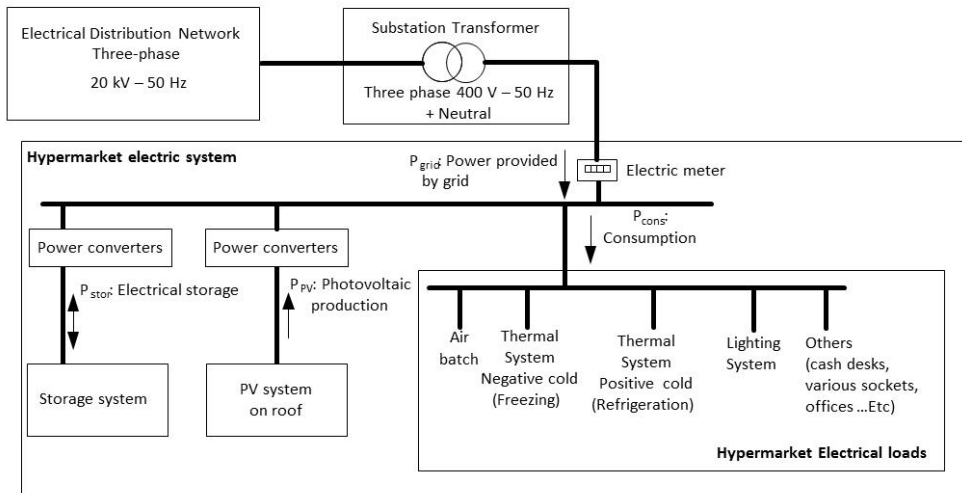

Fig. 15. Electrical network architecture of a commercial building including PV and storage systems.

TABLE 4  
OBJECTIVES, CONSTRAINTS AND MEANS OF ACTION OF THE ENERGY MANAGEMENT STRATEGY

Objectives	Constraints	Means of action
<ul style="list-style-type: none"> <li>To reduce the electricity bill.</li> <li>To balance between the power of peak and off-peak periods to reduce the CO2 emissions.                             <ul style="list-style-type: none"> <li>To ensure the energy availability.</li> </ul> </li> </ul>	<ul style="list-style-type: none"> <li>The electricity price of different periods.</li> <li>The limit of the subscribed power.</li> <li>The limit of the storage capacity.</li> </ul>	<ul style="list-style-type: none"> <li>Reference power of the storage system.</li> </ul>

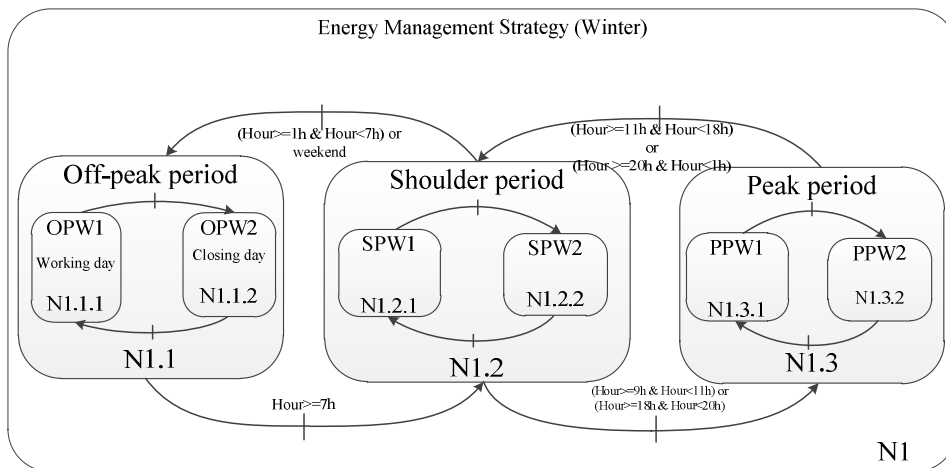

Fig. 16. Chart representation of the fuzzy logic supervision strategies [5].

V. COORDINATED INTEGRATION OF ELECTRIC VEHICLE AND WIND POWER IN ELECTRICAL NETWORK

The French government has made the development of EV and Plug-in Hybrid Vehicles (PHEV) an important priority of its policy to reduce the Green House Gas (GHG) emissions. In 2009, the government has launched a national program to operate 2 million of EVs /PHEVs by 2020. These changes in

the institutional, economic, societal, technical and technological context confront the electrical system actors and particularly the (DSO) to an increasing number of constraints, such as the integration of EV load that will cause many problems on power quality (power losses, voltage drops, overloads, etc.) and generate a significant cost of investment [53,54].



TABLE 5  
COMPARISON OF THE INDICATORS WITH OR WITHOUT STORAGE AND PV SYSTEMS ASSOCIATED WITH THE SUPERVISION SYSTEM

	Annual premium (function of the subscribed power) (€)	Consumption for one week (€)	CO <sub>2</sub> emissions for one week (T)
Case 1	79344	8782	11.604
Case 2	56533	6096	8.541
The difference	-22811 (-28.75%)	-2686 (-30.53%)	-3.063 (-26.40%)

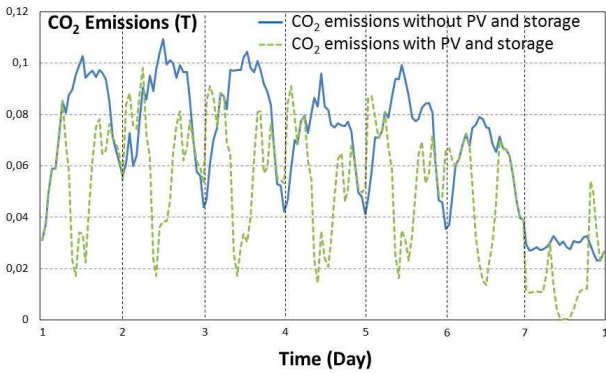

Fig. 17. Comparison of CO<sub>2</sub> emissions.

Similarly, these energy issues make the electrical distribution networks host more and more distributed generation, which may cause problems on protection plans, short-circuit power and voltage quality, etc. [1]. An adequate

control of distributed generation allows providing some ancillary services such as voltage and frequency control [1]. Furthermore, the management of controllable loads (electrical heating, hot water tanks, EV and PHEV) can provide some solutions to the DSO such as reducing peaks power and cost of investment, minimizing losses and voltage drops or obtaining some financial gains [9,10,55,56].

Other studies showed that EVs can be used as a suitable energy storage system for smoothing the generated power by wind farm and increasing its flexibility to participate in the electricity market [9,57]. In [9] fuzzy logic based supervision strategy of EV loads is considered with main objectives to minimize the energy transmission cost and CO<sub>2</sub> emissions by:

- Coordinating EVs and wind power excess (Wind-to-Vehicle (W2V) mechanism);
- Avoiding EVs recharge during peak periods in order to not overtake the DSO subscribed power.

To achieve this goal, the supervision will act on EV loads (shifting load). The supervision strategy will take into account electrical grid load, subscribed power, available wind power on the grid and different EV loads characteristics (connection time, several places charging (home/workplace) and energy requirements).

The study case is applied to an actual test system. As shown in the Fig. 18, the network is supplied by a source station (90/20 kV) which implies 3 transformers (3x36MVA). The subscribed power is 39.6 MW. Approximately 9,000 customers and three wind energy producers (3x12 MW) are connected to this network. The substations have telemetry devices to record the energy flow for 10 minutes period. In 2030, the number of EV charging socket is estimated at 2500 for home and 2400 for workplace.

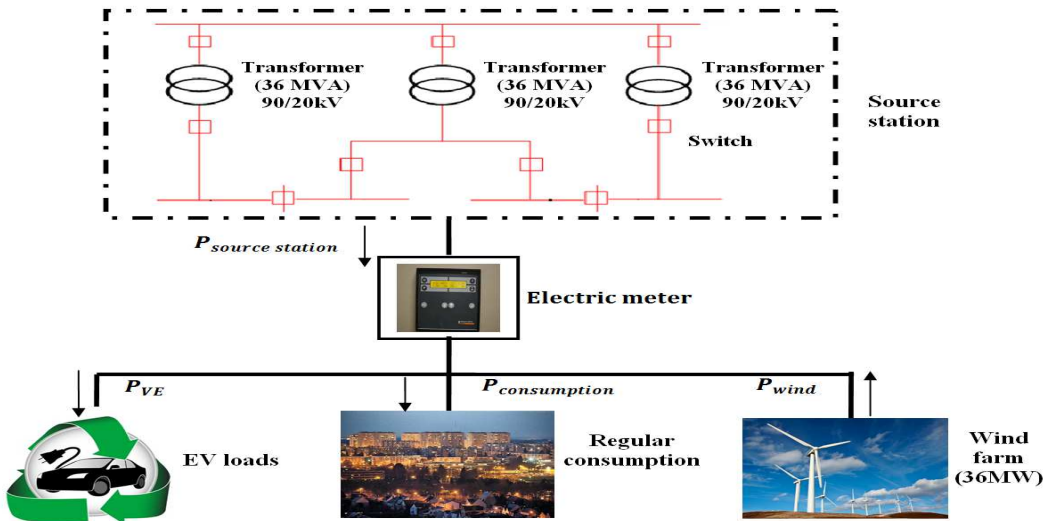

Fig. 18. Test system with wind farm and EV [9].

TABLE 6  
REQUIREMENTS FOR SUPERVISION STRATEGY

Objectives	Constraints	Means of action
Reduce energy transmission cost and CO <sub>2</sub> emissions by : - Promoting of wind power excess. - Avoiding exceeding the subscribed power.	<ul style="list-style-type: none"> <li>The subscribed power limit.</li> <li>Wind power intermittency.</li> <li>The full charging of EVs before departure time:               <ul style="list-style-type: none"> <li>5 p.m. EV at workplace</li> <li>6 a.m EV at home</li> </ul> </li> </ul>	Load Shifting

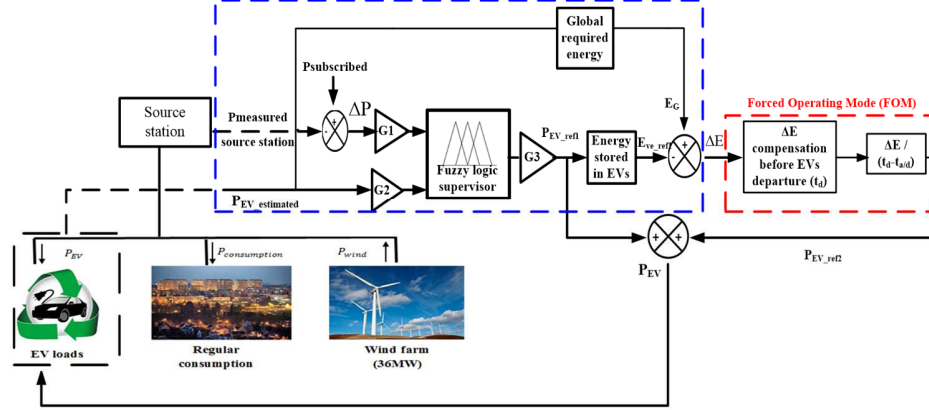

Fig. 19. Architecture of the supervisor [9].

Excess wind energy will be promoted by self-consumption of EV loads, and the grid will provide the missing energy through a source station. The supervision objectives, constraints and means of action are presented in table 6.

The supervisor structure (Fig.19) is organized to achieve the objectives presented in the previous part. The supervisor consists of two blocks:

- The first block is “Fuzzy Logic Operation Mode (FLOM)”, which inputs are:

- The EVs estimated power demand  $P_{EV\_estimated}$ ; this is a function of three variables: number of EVs, connection time and charging time. It is supposed that this is directly reported to the DSO, once EVs are connected to the grid.
- The power difference  $\Delta P$  defined by:

$$\Delta P = P_{subscribed} - P_{measured \text{ source station}}$$

- The second block, “Forced Operating Mode (FOM)” will compensate the energy erased by the first block, in order to ensure the full charging of EVs before departure time.

The fuzzy logic supervisor is designed with the help of the methodology developed in the previous sections. In this case, the eighth step is achieved to tune the parameters of the membership functions with the help of Genetic Algorithms to minimize the energy transmission cost by limiting the overtaking of the subscribed power. The cost reduction during three months obtained with the fuzzy logic supervisor designed with an intuitive approach is 66.6 k€ and with an optimized approach is 70.5 k€. The gain with this second approach is improved by 5.7%.

## VI. CONCLUSION

This paper proposed a survey on the design of fuzzy logic supervisor of storage systems based sources and loads. The management of energy storage systems has been discussed. A methodology to design and to optimize the energy management supervisor has been proposed, based on a multi objectives approach, on fuzzy logic and on indicators as power, energy, efficiency, voltage quality, economic parameters or CO<sub>2</sub> emissions. This method facilitates the analysis and the determination of fuzzy algorithm adapted to complex hybrid systems. The application of this methodology to the supervision of different practical cases, variable speed wind generator associated with a flywheel energy storage system, energy management strategy for commercial building, coordinated integration of electric vehicle and wind power in electrical network, illustrated the performance and the systematic dimension of the proposed approach.

## ACKNOWLEDGMENT

These works were funded by the French Environment and Energy Management Agency (ADEME), the Regional Council Nord-Pas de Calais (France), Séolis Company (Energy supplier in Deux-Sevres/France), Auchan Company and ANRT (Research and Technology National Agency).

## REFERENCES

- [1] B. Robyns, A. Davigny, B. François, A. Henneon, J. Sprooten, "Electric power generation from renewable sources", ISTE-Wiley, ISBN 978-1-8482-1390-6, 2012.
- [2] G. Delille, B. Francois, G. Malarange, "Construction d'une offre de services du stockage pour les réseaux de distribution dans un contexte réglementaire dérégulé", *European Journal of Electrical Engineering*, vol. 12, n°. 5-6, pp. 733-762, 2009.
- [3] J. P. Barton and D. G. Infield, "Energy Storage and Its Use With Intermittent Renewable Energy", *IEEE Trans. on Energy Conversion*, vol. 19, no. 2, pp. 441 – 448, 2004.
- [4] Vazquez, S. Lukic, S.M. Galvan, E. Franquelo, L.G. Carrasco, J.M., "Energy Storage Systems for Transport and Grid Applications", *IEEE Trans. on Industrial Electronics*, vol. 57, n°. 12, pp. 3881-3895, 2010.
- [5] H.Zhang, A.Davigny, F.Colas, Y.Poste, B.Robyns, "Fuzzy Logic based Energy Management Strategy for Commercial Buildings Integrating Photovoltaic and Storage Systems", *Energy and Buildings*, Elsevier, vol.54, pp.196-206, 2012.
- [6] R.Kadri, C.Saudemont, B.Robyns, E.Passchier, A.Millecamps, J-M.Grave, "A Power flow Control Strategy for High Energy Efficient Smart LED Lighting System Powered by PV and MPPT Controlled DC Grid", *IEEE PES International Conference POWERTECH 2013*, Grenoble, 16-20 June 2013.
- [7] H. Kanchev, D. Lu, F. Colas, V. Lazarov, B. Francois, "Energy Management and Operational Planning of a Microgrid With a PV-Based Active Generator for Smart Grid Applications", *IEEE Trans. on Industrial Electronics*, vol. 58, n°. 10, pp. 4583 – 4592, October 2011.
- [8] M. Sechilariu, W. Baochao, F. Locment, "Building Integrated Photovoltaic System With Energy Storage and Smart Grid", *IEEE Trans. on Industrial Electronics*, vol. 60, n° 4, pp.1607 – 1618, April 2013.
- [9] A. Bouallaga, A. Merdassi, A. Davigny, V. Courtecuisse, B. Robyns, "Minimization of Energy Transmission Cost and CO<sub>2</sub> Emissions using Coordination of Electric Vehicle and Wind Power (W2V)", *IEEE PES International Conference POWERTECH 2013*, Grenoble, 16-20 June 2013.
- [10] S. Sarabi, L. Kefsi, A. Merdassi, B. Robyns, "Vehicle to Grid - Supervision of Plug-in Electric Vehicles (PEVs) Connected to the Electric Distribution Grid", *ICCEE 2013, 6th International Conference on Computer and Electrical Engineering*, Paris, 12-13 October 2013.
- [11] P. Pankovits, M. Ployard, J. Pouget, S. Brisset, D. Abbes, B. Robyns, "Design and Operation Optimization of a Hybrid Railway Power Substation", *15th Conference EPE 2013 ECCE Europe*, Lille, 3-5 September 2013.
- [12] A. Jaafar, C.R. Akli, B. Sareni, X. Roboam, A. Jeunesse, "Sizing and Energy Management of a Hybrid Locomotive Based on Flywheel and Accumulators", *IEEE Trans. on Vehicular Technology*, vol. 58, n° 8, pp. 3947 – 3958, 2009.
- [13] M. H. Nehrir, C. Wang, K. Strunz, H. Aki, R. Ramakumar, J. Bing, Z. Miao, and Z. Salameh, "A Review of Hybrid Renewable/Alternative Energy Systems for Electric Power Generation: Configurations, Control, and Applications", *IEEE Trans. On Sustainable Energy*, vol. 2, n°. 4, October 2011.
- [14] X. Roboam, "Systemic Design Methodologies for Electrical Energy Systems", ISTE-Wiley, ISBN 9781848213883, 2012.
- [15] B. Robyns, A. Davigny, C. Saudemont, "Methodologies for supervision of hybrid energy sources based on storage systems – A survey", *Mathematics and Computers in Simulation*, Elsevier, vol.91, pp.52-71, May 2013.
- [16] G. Delille, B. Francois, G. Malarange, "Dynamic Frequency Control Support by Energy Storage to Reduce the Impact of Wind and Solar Generation on Isolated Power System's Inertia", *IEEE Trans. on Sustainable Energy*, vol. 3, n°. 4, pp. 931-939, October, 2012.
- [17] H. Fakham, D. Lu, B. Francois, "Power Control Design of a battery charger in a Hybrid Active PV generator for load-following applications", *IEEE Trans. on Industrial Electronics*, vol. 58, n°1, pp. 85-94, 1-2011.
- [18] T. Zhou, B. Francois, "Energy Management and Power Control of an Hybrid Active Wind Generator for Distributed Power Generation and Grid Integration", *IEEE Trans. on Industrial Electronics*, vol. 58, n°. 1, pp. 95-104, January 2011.
- [19] Anne-Laure Allègre, Alain Bouscayrol, Philippe Delarue, Philippe Barrade, Eric Chatot, Said El-Fassi, "Energy Storage System With Supercapacitor for an Innovative Subway", *IEEE Trans. on Industrial Electronics*, vol. 57, n° 12, pp. 4001- 4012, December 2010.
- [20] X. Roboam, "Integrated Design by Optimization of Electrical Energy Systems", ISTE-Wiley, ISBN 9781848213890, 2012.
- [21] R. B. Chedid, S. H. Karaki, C. El – Chamali, "Adaptive fuzzy control for wind – diesel weak power systems", *IEEE Trans. on Energy Conversion* vol. 15, n°1, pp. 71–78, 2000.
- [22] L.Leclercq, B.Robyns, J.M.Grave,"Control based on fuzzy logic of a flywheel energy storage system associated with wind and diesel generators", *Mathematics and Computers in Simulation*, Elsevier, vol. 63, pp.271-280, 2003.
- [23] V.Courtecuisse, J.Sprooten, B.Robyns, M.Petit, B.François, J.Deuse, "Methodology to build fuzzy logic based supervision of hybrid renewable energy systems", *Mathematics and Computers in Simulation*, Elsevier, vol.81, pp.208-224, october 2010.
- [24] H.Zhang, F.Mollet, C.Saudemont, B.Robyns, "Experimental validation of energy storage system management strategies for a local DC distribution system of More Electric Aircraft", *IEEE Trans. on Industrial Electronics*, vol.57, n°12, pp.3905-3916, December 2010.
- [25] Javier Solano Martínez, Daniel Hissel, Marie-Cécile Péra, Michel Amiet, "Practical Control Structure and Energy Management of a Testbed Hybrid Electric Vehicle", *IEEE Trans. on Vehicular Technology*, vol. 60, n°. 9, pp. 4139 – 4152, November 2011.
- [26] Javier Solano Martínez, Robert I. John, Daniel Hissel, Marie-Cécile Péra, "A survey-based type-2 fuzzy logic system for energy management in hybrid electrical vehicles", *Information Sciences* 190, pp. 192–207, 2012.
- [27] Jérémy Lagorse, Marcelo G. Simões, Abdellatif Miraoui, "A Multiagent Fuzzy-Logic-Based Energy Management of Hybrid Systems", *IEEE Trans. on Industry Applications*, vol. 45, n° 6, pp. 2123 – 2129, November/December 2009.
- [28] P. Vas, "Artificial-Intelligence-Based Electrical Machine and Drive". U.K.: Oxford Science, Oxford, 1999.
- [29] B. Robyns, B. François, P. Degobert, J-P. Hautier, "Vector Control of Induction Machines. Desensitisation and Optimisation Through Fuzzy Logic", Springer Verlag, ISBN 978-0-85729-900-0, 2012.
- [30] R. Zurawski, M. Zhou, "Petri net and industrial application: A tutorial", *IEEE Trans. on Industrial Electronics*, Vol. 41, n°6, pp. 567-583, 1994.
- [31] D. Lu, H. Fakham, T. Zhou, B. Francois, "Application of Petri Nets for the energy management of a photovoltaic based power station including storage units", *Renewable Energy*, Elsevier, vol. 35, n°. 6, pp. 1117-1124, 6-2010.
- [32] L. Guillemaud, H. Guegen, "Extending Grafcet for the specification of control of hybrid systems", *IEEE International Conference on Systems, Man, and Cybernetics*, Tokyo, pp. 171-175, 1999.
- [33] S.Breban, C.Saudemont, S.Vieillard, B.Robyns, "Experimental design and genetic algorithm optimization of a fuzzy logic supervisor for embedded electrical power systems", *Mathematics and Computers in Simulation*, Elsevier, vol.91, pp. 91-107, may 2013.
- [34] Aihua Wang, Weizi Yang, "Design of Energy Management Strategy in Hybrid Vehicles by Evolutionary Fuzzy System,Part II: Tuning Fuzzy Controller by Genetic Algorithms", *Proceedings of the 6th World Congress on Intelligent Control and Automation*, , Dalian, China, June 21 - 23, 2006.
- [35] Huai-Xiang Zhang, Feng Wang, Bo Zhang, "Genetic Optimization Of Fuzzy Membership", *Functions Proceedings of the 2009 International Conference on Wavelet Analysis and Pattern Recognition*, Baoding, 12-15 July 2009.
- [36] Chun-Juan Liu, Bian-Xia Li, Xiao-xu Yang, "Fuzzy Logic Controller Design Based on Genetic Algorithm for DC Motor", *International Conference on Electronics, Communications and Control (ICECC)*, 2011.
- [37] B. Liu, S. Duan, Y. Kang, J. Chen, "Optimization of Scaling Factors of Fuzzy-Logic Controller for CVCF Inverter by Genetic Algorithm", *Proceedings of the Eighth International Conference on Electrical Machines and Systems, ICEMS*, Nanjing, pp. 1396-1400, 2005.
- [38] M. Mohammadian, R J Stonier, Tuning and Optimization of Membership functions of Fuzzy Logic Controllers by Genetic Algorithms, *IEEE International Workshop on Robot and Human Communication*, Nagoya, Japan, pp. 356-361, 1994.
- [39] Y. J. Park, H. S. Cho, D. H. Cha, Genetic algorithm-based optimization of fuzzy logic controller using characteristic parameters, *IEEE International Conference on Evolutionary Computation*, Perth, Australia, vol. 2, pp. 831-836, 1995.

- [40] J. Faucher, S. Caux, P. Maussion, "Fuzzy Controller tuning of a Boost Rectifier Unity Power Correction with Experimental Designs", *Electrical Engineering (Archiv fur Elektrotechnik)*, vol. 91, n°3, pp. 167-176, 2009.
- [41] J-C.Swierczek, F.Mollet, C.Saudemont, R.Meuret, B.Robyns, "Power management of a regenerative local HVDC aircraft network using supercapacitors", 15th International Power Electronics and Motion Control Conference, EPE-PEMC 2012 ECCE Europe, Novi Sad, Serbia, 4-6 september 2012.
- [42] F.Mollet, S.Breban, C.Saudemont, R.Meuret, B.Robyns, "Design and Supervision Strategies for Embedded Electrical Power Systems Equipped with Energy Storage Devices", 14th Conference EPE 2011, Birmingham, 30 july-1 september 2011.
- [43] R. Cardenas, R. Pena, G. Asher, J. Clare, "Control strategies for enhanced power smoothing in wind energy systems using a flywheel driven by a vector-controlled induction machine", *IEEE Trans. on Industrial Electronics*, vol. 48, n°3, pp. 625-635, 2001.
- [44] L.Leclercq, C.Saudemont, B.Robyns, G.Cimuca, M.Radulescu, "Flywheel energy storage system to improve the integration of wind generators into a grid", *Electromotion*, vol.10, n°4, pp.641-646, 2003.
- [45] R. Cardenas, R. Pena, G. Asher, J. Clare, R. Blasco-Giménez, "Control strategies for power smoothing using a flywheel driven by a sensorless vector-controlled induction machine operating in a wide speed range", *IEEE Trans. on Industrial Electronics*, vol. 51, n°3, pp. 603-614, 2004.
- [46] G.Cimuca, C.Saudemont, B.Robyns, M.Radulescu, "Control and performance evaluation of a flywheel energy storage system associated to a variable speed wind generator", *IEEE Trans. on Industrial Electronics*, vol.53, n°4, pp.1074-1085, August 2006.
- [47] A. Davigny, B. Robyns, "Fuzzy logic based supervisor of a wind farm including storage system and able to work in islanding mode", *IEEE 32<sup>nd</sup> Annual Conference on Industrial Electronics, IECON*, pp. 4231 – 4236, 2006.
- [48] G.Cimuca, S.Breban, M.Radulescu, C.Saudemont, B.Robyns, "Design and control strategies of an induction machine-based flywheel energy-storage system associated to a variable-speed wind generator", *IEEE Trans. on Energy Conversion*, vol. 25, n°2, pp.526-534, June 2010.
- [49] L.J. Ricalde, M. Gamez, E.N. Sanchez, "Design of a smart grid management system with renewable energy generation", *IEEE Symposium on Computational intelligence Applications In Smart Grid (CIASG)*, Paris, ISBN: 978-1-4244-9893-2, pp. 1-4, 2011.
- [50] M. Sechilariu, F. Locment, I. Houssamo, "Multi-source power generation system in semi-isolated and safety grid configuration for buildings", 15th IEEE Mediterranean Electrotechnical Conference (MELECON), Malta, pp. 967-972, 2010.
- [51] RTE, French electricity transmission system operator, <http://clients.rte-france.com>.
- [52] RTE, French electricity transmission system operator, <http://www.rte-france.com/fr/developpement-durable/eco2mix>.
- [53] K. Clement-Nyns, E. Haesen and J. Driesen, "The Impact of Charging Plug-In Hybrid Electric Vehicles on a Residential Distribution Grid", *IEEE Trans. on power systems*, vol. 25, n°1, Feb. 2010.
- [54] L.P. Fernández, T.G. San Román, R. Cossent, C.M. Domingo, and P. Frías, "Assessment of the Impact of Plug-In Electric Vehicles on Distribution Networks" *IEEE Trans. on Power Systems*, vol. 26, n°1, 2011.
- [55] Z. Li, A. Khaligh, and N. Sabbaghi, "Minimum Charging-Cost Tracking Based Optimization Algorithm with Dynamic Programming Technique for Plug-In Hybrid Electric Vehicles", *Vehicle Power and Propulsion Conf.*, IEEE, 2011.
- [56] Y. Cao, S. Tang, C. Li, P. Zhang, Y. Tan, Z. Zhang, and J. Li., "An Optimized EV Charging Model Considering TOU Price and SOC Curve", *IEEE Trans. on Smart Grid*, 2012.
- [57] M. E. Khodayar, LeiWu and M. Shahidehpour, "Hourly Coordination of Electric Vehicle Operation and Volatile Wind Power Generation in SCUC", *IEEE trans. on smart grid*, vol. 3, n°. 3, Sept. 2012.