



**HAL**  
open science

## Re-Energization of a Power System with a Distribution Network

Yorgo Laba, Frederic Colas, Antoine Bruyere, Xavier Guillaud, Xavier Legrand, Thibault Presvost, Gilles Torresan

► **To cite this version:**

Yorgo Laba, Frederic Colas, Antoine Bruyere, Xavier Guillaud, Xavier Legrand, et al.. Re-Energization of a Power System with a Distribution Network. CIRED Workshop on Resilience of Electric Distribution Systems, Nov 2024, Chicago, IL, France. hal-04804494

**HAL Id: hal-04804494**

**<https://hal.univ-lille.fr/hal-04804494v1>**

Submitted on 26 Nov 2024

**HAL** is a multi-disciplinary open access archive for the deposit and dissemination of scientific research documents, whether they are published or not. The documents may come from teaching and research institutions in France or abroad, or from public or private research centers.

L'archive ouverte pluridisciplinaire **HAL**, est destinée au dépôt et à la diffusion de documents scientifiques de niveau recherche, publiés ou non, émanant des établissements d'enseignement et de recherche français ou étrangers, des laboratoires publics ou privés.

## RE-ENERGIZATION OF A POWER SYSTEM WITH A DISTRIBUTION NETWORK

Yorgo Laba  
L2EP/Centrale Lille Institute – France  
[yorgo.laba@centralelille.fr](mailto:yorgo.laba@centralelille.fr)

Frédéric Colas  
L2EP/ENSAM - France  
[frederic.colas@ensam.eu](mailto:frederic.colas@ensam.eu)

Antoine Bruyère  
L2EP/Centrale Lille Institute – France  
[antoine.bruyere@centralelille.fr](mailto:antoine.bruyere@centralelille.fr)

Xavier Guillaud  
L2EP/Centrale Lille Institute – France  
[xavier.guillaud@centralelille.fr](mailto:xavier.guillaud@centralelille.fr)

Xavier Legrand  
ENEDIS – France  
[xavier.legrand@enedis.fr](mailto:xavier.legrand@enedis.fr)

Thibault Prevost  
RTE – France  
[thibault.prevost@rte-france.com](mailto:thibault.prevost@rte-france.com)

Gilles Torresan  
RTE – France  
[gilles.torresan@rte-france.com](mailto:gilles.torresan@rte-france.com)

### ABSTRACT

*The evolving energy mix increasingly integrates variable renewable energy systems into power grids, prompting the exploration of alternative black-start approaches at the distribution network. This study focuses on the use of distributed resources connected via power electronics converters to supply loads at the distribution level through transformers, following a blackout of the transmission system. Energizing transformers generates high unbalanced inrush currents with harmonics due to iron core saturation, posing a significant challenge. Unlike synchronous machines, power electronic converters cannot support large inrush currents. This paper demonstrates a grid-forming control that provides high-quality voltage while protecting the converter by limiting the inrush current. A benchmark is then implemented to illustrate the use of grid-forming to energize multiple transformers during a distributed black-start. It also demonstrates the ability of the proposed grid-forming to synchronize with an existing grid.*

### INTRODUCTION

In the event of a partial or total blackout, Transmission System Operators (TSOs) carry the responsibility of system restoration. Traditionally, this complex process relies on large power plants, either with black-start or islanding capabilities, to re-energize sections of the power system. This allows other large power plants to be restarted, and so forth [1]. In France, this is mainly achieved through nuclear and hydroelectric power. During this critical phase, the transmission system plays an essential role, while the distribution system typically remains passive, as it is not directly involved in these restoration measures.

With the large development of Renewable Energy Sources (RESs) within distribution networks, the traditional restoration scheme could evolve. The approach could involve local production units and Battery Energy Storage Systems (BESSs) within the distribution network to actively participate in the restoration of both distribution and, in some cases, transmission grids. In Great Britain, a world-first initiative project paved the way for the concept of distributed restart, exploring the use of distributed resources to restore power during blackout events [2].

This paper explores BESS interfaced with the grid using a Power Electronic (PE) converter. This converter is crucial for distributed restart processes as it has to regulate voltage and frequency [3]. In this context, the Grid-Forming (GFM) control has emerged in the literature as a potential strategy to generate voltage waveforms, functioning akin to a controlled voltage source [4], [5].

However, implementing this innovative concept involves numerous challenges, with transformer energization being among the top ones. Hard energization of transformers can lead to significant unbalanced inrush currents, potentially accompanied by harmonics, depending on the saturation level of the transformer's iron core [6], [7], [8]. Limiting these inrush effects is crucial in planning and designing distributed black-start strategies [9]. To address these challenges, the GFM has to switch from providing high-quality voltage and frequency in normal operation to advanced current management during the transformer re-energization phase to prevent the BESS from tripping.

In the literature, research on the capability of GFM to energize transformers has begun. A comprehensive review highlighted the role of GFM in the energization process [10]. Controlled switching and soft energization in GFM have been assessed in [11], though challenges persist regarding an accurate knowledge of the saturation curve, residual flux, and delays of circuit breakers (CBs). [3], [12] illustrated the soft energization through a voltage ramp, yet defining an appropriate ramping time remains challenging due to varying operating conditions.

In this paper, the GFM does not require transformer data, residual flux information, or CB delays, enabling instantaneous transformer pickup. In this context, [13] illustrates the concept of implementing a Transient Virtual Resistance (TVR) to dampen inrush current. However, it does not directly address saturation in current control. [14] demonstrate an experimentally validated GFM based on droop control. It implements cascaded voltage and current control loops in the stationary frame, limiting inrush current by adjusting current or voltage references. However, defining the optimum parameters of the controllers remains challenging.

This article demonstrates the effectiveness of a proposed



source” characteristic, a reverse function is added to the control setup. During normal operation, the dynamics of the PI controller of the current control are eliminated by the "Inverse Current Loop". The system also includes a TVR of 0.09 pu for quick damping, a virtual inductance of 0.3 pu, and Automatic Voltage Regulation (AVR) at the Point of Common Coupling (PCC) to stabilize voltage levels. For the active power control, a GFM embedding an inertial effect with frequency droop control of 4 % is employed [5]. For DC voltage, the DC voltage controls are not modeled, and the DC bus voltage is considered fixed. In addition, the model takes into account the converter's voltage limitation. Further details are provided in [16].

## TRANSFORMER ENERGIZATION: RESULTS INTERPRETATION

### Energization using an ideal voltage source

First, the VSC is replaced by an ideal three-phase source. Fig. 3 illustrates the three-phase current provided when T2 is energized at  $t = 0.1$  s. The results are presented in pu with the base linked to the converter. The results demonstrate that hard energization can lead to a high unbalanced inrush current, potentially exceeding 4 pu, depending on the saturation level. Consequently, when the VSC is implemented, the inrush current must be limited to prevent potential damage to the system components.

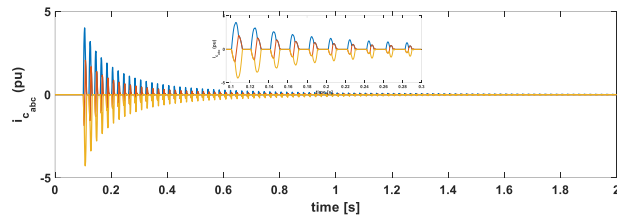

Fig. 3: Inrush current waveform during hard energization.

### Energization using the proposed Grid-Forming

The transformer energization is now performed using the GFM. The results are presented in Fig. 4 and Fig. 5. The GFM successfully saturates the first peak of the inrush current due to the automatic activation of the current control, which overrides the references from the "Inverse Current Control" block during this period. This current control mechanism effectively limits the magnitude of the inrush current, followed by an exponential decay. This decay is further damped due to the implementation of the TVR. Conversely, the impact of limiting the inrush current during the initial moments of transformer energization can be seen on the voltage side (See Fig. 5). Specifically, the voltage at the PCC becomes distorted to align with the saturated current references set by the "current loop". Nevertheless, after the initial peaks are saturated and the transformer becomes energized, the voltage gradually returns to its sinusoidal waveform, maintaining its good quality in steady state. Fig. 6 illustrates the connection of the load. It demonstrates that the load is effectively supplied with the required active and reactive power.

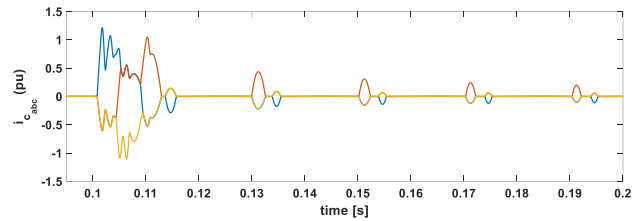

Fig. 4: Inrush current waveform after GFM implementation

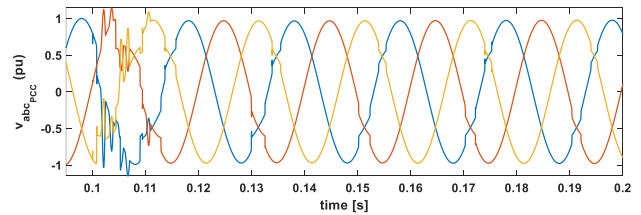

Fig. 5: PCC Voltage following GFM implementation.

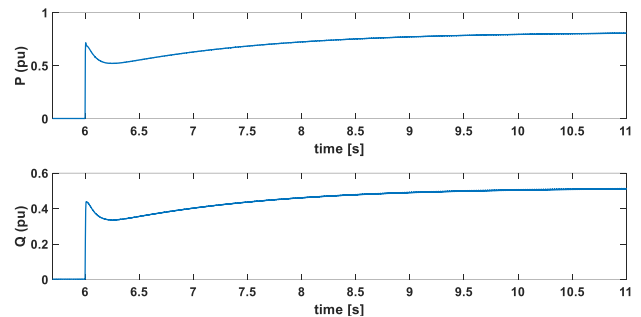

Fig. 6: Active and reactive power waveforms after the connection of the RL load at  $t = 6$  s.

## APPLICATION OF GRID-FORMING TO A BENCHMARK SCENARIO

### Benchmark Definition

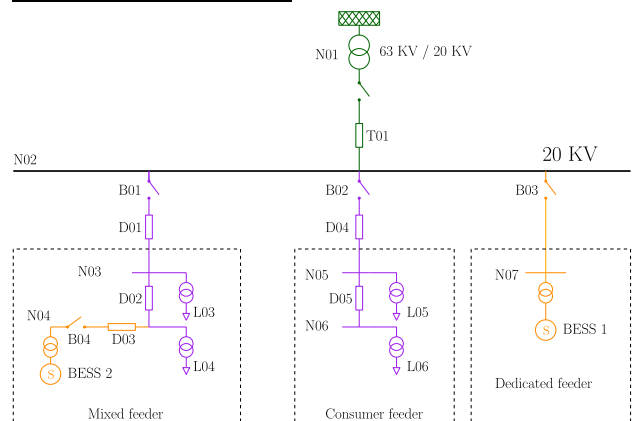

Fig. 7: Presentation of the proposed MV benchmark constituted with three feeders.

The benchmark for this study is designed to establish a framework for restoring power in a distributed black-start scenario, ensuring the re-energization of critical loads. It comprises three types of feeders, as illustrated in Fig. 7:

1. **Production Feeder:** It is connected to a BESS GFM with a nominal power of 11 MVA. It plays a crucial role in the initial stages by energizing

other transformers within the distribution level.

2. **Consumer Feeder:** It consists of two loads.
3. **Mixed Feeder:** It includes another BESS GFM with a nominal power of 4 MVA, along with two loads. The BESS 2, although initially inactive, is integrated into the re-energization process to supplement the power provided by the BESS 1.

All loads are interconnected via a MV/LV transformer with the same magnetic characteristics as listed in Table 1, and the corresponding transformer has a nominal power equal to the apparent power of the load. The characteristics of the distribution lines are found in Table 2. The four considered RL loads are described in Table 3.

Table 2: Distribution lines characteristics.

Line	D01	D02	D03	D04	D05
<b>L (mH)</b>	0.66	0.56	0.2	1.75	0.19
<b>R (<math>\Omega</math>)</b>	0.41	0.35	0.18	0.72	0.11

Table 3: Loads characteristics.

Load	L03	L04	L05	L06
<b>S (MW)</b>	3	1	6	4
<b>Cos <math>\Phi</math></b>	0.85	0.95	0.8	0.9

### Scenario description

The proposed re-energization scenario is divided into several key phases, detailed as follows:

1. **Initial Activation:** The dedicated feeder (BESS 1) is activated by closing B03, establishing the initial voltage source.
2. **Loads Connection (t = 3 s):** B01 is closed while maintaining B04 open. Consequently, L03 and L04 are directly connected.
3. **Connection of BESS 2 (t = 6 s):** BESS 2, also operating as a GFM, is connected to the grid by closing B04 to assist BESS 1 in the power supply. Initially, before connecting BESS 2, The two BESSs are not synchronized. This setup evaluates the ability of the proposed GFM of BESS 2 to synchronize with the grid during a blackout.
4. **Connection of the Consumer Feeder (t = 9 s):** B02 is closed to supply L05 and L06.

The objective is to demonstrate that the proposed re-energization strategy with the GFM can effectively manage the distribution network, maintaining voltage quality, and limiting current to acceptable levels, thereby ensuring a reliable and efficient power restoration process.

### Simulation and Results

Fig. 8 and Fig. 9 illustrate the current provided by BESS 1 and BESS 2, respectively. The pu values in each figure correspond to the base of each converter. As shown, the current is limited in all cases where transformers are energized. At t = 3 s, BESS 1 provides the required current to supply the loads of the mixed feeders. At t = 6 s, when

BESS 2, operating as a GFM, is connected, the power is shared between the two converters according to their nominal power ratings. At t = 9 s, the consumer feeder is connected and it is supplied the required power shared between BESS 1 and BESS 2. Fig. 10 compares the voltage at BESS 2 between the grid side and the converter side to evaluate the GFM's capability to resynchronize with an existing grid. The results demonstrate that the voltage successfully resynchronizes with the grid phase. This connection could be considered a 'pessimistic' approach, as the VSC can measure and align the phase before connecting, thereby avoiding transients. In conclusion, the proposed control effectively energized the transformers, supplied the loads, and demonstrated its efficiency in synchronizing with an existing grid.

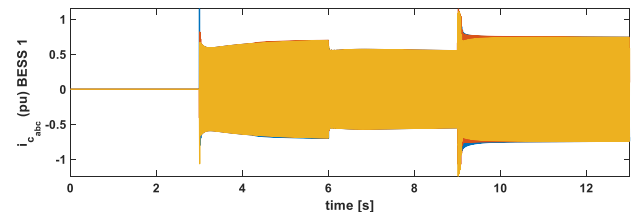

Fig. 8: Current waveform provided by BESS 1.

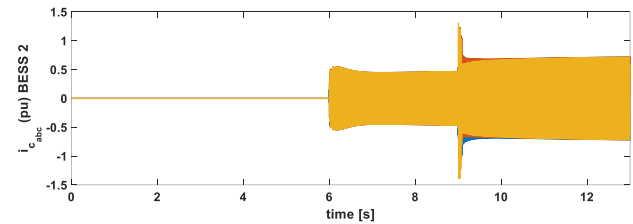

Fig. 9: Current waveform provided by BESS 2.

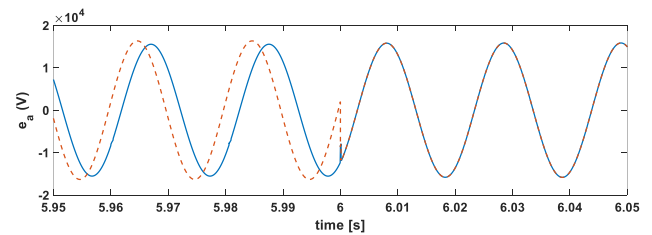

Fig. 10: Comparison of Phase A Voltage at BESS 2 level: Converter Side (red) and Grid Side (blue).

### CONCLUSION

As the integration of BESSs into the distribution network increases, the need for innovative black-start strategies at the distribution level becomes critical. This paper provides an examination of the challenges associated with the distributed restart process, with a focus on energizing the distribution grid using a converter operating as a GFM, a role traditionally filled by synchronous machines.

A GFM control was described, designed to limit inrush currents, thereby protecting components and ensuring the recovery of a sinusoidal voltage waveform. The study was extended to the simultaneous energization of multiple loads within a benchmark scenario, as well as the integration of an additional GFM control to help in power

supply. Furthermore, the results demonstrated the control's effectiveness in re-synchronizing with an existing grid. It is noteworthy that energizing a larger HV/MV transformer in the transmission network can lead to wider constraints due to the potential for stronger inrush currents. Additionally, rapid changes in voltage to limit currents might pose challenges for the protection systems. Consequently, future work will focus on testing the energization of the HV/MV transformer using the GFM converter to better mitigate these challenges.

## ACKNOWLEDGEMENTS

Appreciative acknowledgment to ENEDIS and RTE for their participation and support in this work.

## REFERENCES

- [1] Y. Liu, R. Fan, and V. Terzija, "Power system restoration: a literature review from 2006 to 2016," *J. Mod. Power Syst. Clean Energy*, vol. 4, no. 3, pp. 332–341, Jul. 2016.
- [2] Great Britain National Grid Electricity System Operator (ESO), "Distributed ReStart," 2023, [Online]. Available: <https://www.nationalgrideso.com/future-energy/projects/distributed-restart>
- [3] A. Alassi, Z. Feng, K. Ahmed, M. Syed, A. Egea-Alvarez, and C. Foote, "Grid-forming VSM control for black-start applications with experimental PHIL validation," *International Journal of Electrical Power & Energy Systems*, vol. 151, p. 109119, Sep. 2023.
- [4] ENTSO-E, ENTSO-E, "High Penetration of Power Electronic Interfaced Power Sources and the Potential Contribution of Grid Forming Converters," Tech. Rep., 2020. [Online]. Available: [https://www.entsoe.eu/Documents/Publications/SOC/High\\_Penetration\\_of\\_Power\\_Electronic\\_Interfaced\\_Power\\_Sources\\_and\\_the\\_Potential\\_Contribution\\_of\\_Grid\\_Forming\\_Converters.pdf](https://www.entsoe.eu/Documents/Publications/SOC/High_Penetration_of_Power_Electronic_Interfaced_Power_Sources_and_the_Potential_Contribution_of_Grid_Forming_Converters.pdf)
- [5] T. Qoria, E. Rokrok, A. Bruyere, B. Francois, and X. Guillaud, "A PLL-Free Grid-Forming Control With Decoupled Functionalities for High-Power Transmission System Applications," *IEEE Access*, vol. 8, pp. 197363–197378, 2020.
- [6] L. Hagemann, K. Hetzenecker, J. Kleutgens, and R. W. De Doncker, "Modeling Inrush Currents in Medium-Voltage Grids," in *2023 25th European Conference on Power Electronics and Applications (EPE'23 ECCE Europe)*, Aalborg, Denmark: IEEE, Sep. 2023, pp. 1–8.
- [7] N. Chiesa, B. A. Mork, and H. K. Høidalen, "Transformer Model for Inrush Current Calculations: Simulations, Measurements and Sensitivity Analysis," *IEEE Trans. Power Delivery*, vol. 25, no. 4, pp. 2599–2608, Oct. 2010.
- [8] H. Dashti, M. Davarpanah, M. Sanaye-Pasand, and H. Lesani, "Discriminating transformer large inrush currents from fault currents," *International Journal of Electrical Power & Energy Systems*, vol. 75, pp. 74–82, Feb. 2016.
- [9] P. Linnartz, N. Schulte, and S. Simon, "558Experimental investigation of distribution grid restoration concepts using neighboring islanded LV-microgrids." AIM, Jun. 03, 2019.
- [10] A. Jain, J. N. Sakamuri, and N. A. Cutululis, "Grid-forming control strategies for black start by offshore wind power plants," *Wind Energ. Sci.*, vol. 5, no. 4, pp. 1297–1313, Oct. 2020.
- [11] A. Alassi, K. H. Ahmed, A. Egea-Alvarez, and C. Foote, "Transformer Inrush Current Mitigation Techniques for Grid-Forming Inverters Dominated Grids," *IEEE Trans. Power Delivery*, pp. 1–11, 2022.
- [12] J. Westman, R. Hadidi, C. Fox, and J. Leonard, "Energization of Transformers in Medium Voltage Island Microgrids by Leveraging Grid Forming Inverter Control," in *2021 IEEE/IAS 57th Industrial and Commercial Power Systems Technical Conference (I&CPS)*, Las Vegas, NV, USA: IEEE, Apr. 2021, pp. 1–8.
- [13] A. Jain, O. Saborio-Romano, J. N. Sakamuri, and N. A. Cutululis, "Virtual Resistance Control for Sequential Green-Start of Offshore Wind Power Plants," *IEEE Trans. Sustain. Energy*, vol. 13, no. 3, pp. 1420–1429, Jul. 2022.
- [14] M. Shahparasti, H. Laaksonen, K. Kauhaniemi, P. Lauttamus, S. Strandberg, and J. Strandberg, "Inrush Current Management During Medium Voltage Microgrid Black Start With Battery Energy Storage System," *IEEE Access*, vol. 10, pp. 42287–42296, 2022, doi: 10.1109/ACCESS.2022.3167701.
- [15] ENTSO-E, "COMMISSION REGULATION (EU) 2016/ 631 - of 14 April 2016 - establishing a network code on requirements for grid connection of generators." 2016. [Online]. Available: <https://op.europa.eu/>
- [16] C. Cardozo *et al.*, "Promises and Challenges of Grid Forming: Transmission System Operator, Manufacturer and Academic View Points," in *Power Systems Computation Conference (PSCC), 2024*, Paris, France, 2024, pp. 1–35.